



OM-275099E

2019-01

Processes



Stick (SMAW) Welding



TIG (GTAW) Welding

Description



Arc Welding Power Source

Maxstar[®] 161 S, STL, and STH

With Auto-Line™

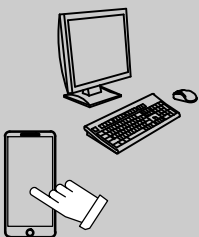
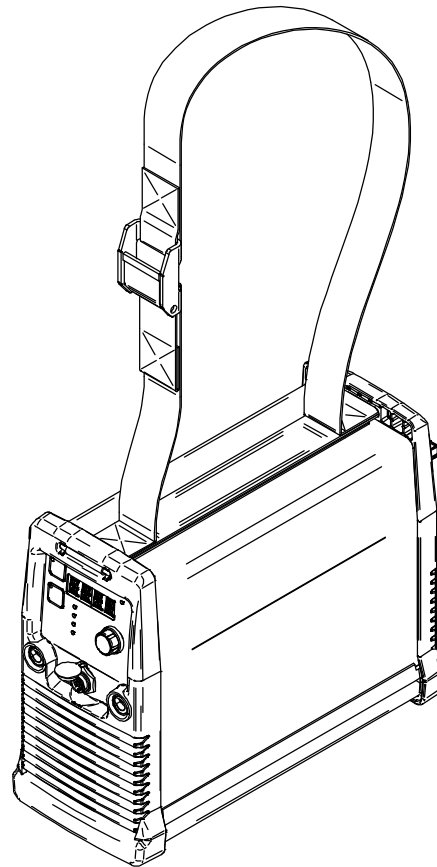

For product information,
Owner's Manual translations,
and more, visit

www.MillerWelds.com

OWNER'S MANUAL

File: TIG (GTAW)



From Miller to You

Thank you and congratulations on choosing Miller. Now you can get the job done and get it done right. We know you don't have time to do it any other way.

That's why when Niels Miller first started building arc welders in 1929, he made sure his products offered long-lasting value and superior quality. Like you, his customers couldn't afford anything less. Miller products had to be more than the best they could be. They had to be the best you could buy.

Today, the people that build and sell Miller products continue the tradition. They're just as committed to providing equipment and service that meets the high standards of quality and value established in 1929.

This Owner's Manual is designed to help you get the most out of your Miller products. Please take time to read the Safety Precautions. They will help you protect yourself against potential hazards on the worksite.



ISO 9001
Quality

Miller is the first welding equipment manufacturer in the U.S.A. to be registered to the ISO 9001 Quality System Standard.

We've made installation and operation quick and easy. With Miller, you can count on years of reliable service with proper maintenance. And if for some reason the unit needs repair, there's a Troubleshooting section that will help you figure out what the problem is, and our extensive service network is there to help fix the problem. Warranty and maintenance information for your particular model are also provided.



Miller Electric manufactures a full line of welders and welding-related equipment. For information on other quality Miller products, contact your local Miller distributor to receive the latest full line catalog or individual specification sheets. **To locate your nearest distributor or service agency call 1-800-4-A-Miller, or visit us at www.MillerWelds.com on the web.**



Working as hard as you do – every power source from Miller is backed by the most hassle-free warranty in the business.



TABLE OF CONTENTS

SECTION 1 – SAFETY PRECAUTIONS - READ BEFORE USING	1
1-1. Symbol Usage	1
1-2. Arc Welding Hazards	1
1-3. Additional Symbols For Installation, Operation, And Maintenance	3
1-4. California Proposition 65 Warnings	4
1-5. Principal Safety Standards	4
1-6. EMF Information	4
SECTION 2 – CONSIGNES DE SÉCURITÉ – LIRE AVANT UTILISATION	5
2-1. Symboles utilisés	5
2-2. Dangers relatifs au soudage à l'arc	5
2-3. Dangers supplémentaires en relation avec l'installation, le fonctionnement et la maintenance	7
2-4. Proposition californienne 65 Avertissements	8
2-5. Principales normes de sécurité	8
2-6. Informations relatives aux CEM	8
SECTION 3 – DEFINITIONS	9
3-1. Additional Safety Symbols And Definitions	9
3-2. Miscellaneous Symbols And Definitions	10
SECTION 4 – SPECIFICATIONS	11
4-1. Serial Number And Rating Label Location	11
4-2. Specifications	11
4-3. Dimensions And Weight	11
4-4. Environmental Specifications	12
4-5. Duty Cycle And Overheating For Maxstar 161S Models	12
4-6. Static Characteristics	13
4-7. Remote 6 Receptacle Information (STL And STH Models Only)	13
SECTION 5 – INSTALLATION	14
5-1. Selecting a Location	14
5-2. Electrical Service Guide	15
5-3. Input Power Extension Cord Data	15
5-4. Connecting 120 VAC Input Power	16
5-5. Connecting 1-Phase Input Power For 240 VAC	18
5-6. Shoulder And Handle Strap Installation	20
SECTION 6 – OPERATION	21
6-1. Front Panel Controls And Gas Connection	21
6-2. Process Selection (STL Model Only)	21
6-3. Process Selection (STH Model Only)	22
6-4. Process Selection (S Model Only)	22
6-5. Lift-Arc And TIG Impulse Start Procedures	23
6-6. Accessing Control Panel Menu: TIG–HF (STH Model Only)	23
6-7. Accessing Control Panel Menu: Lift-Arc TIG (STH And STL Models Only)	24
SECTION 7 – ADVANCED MENU FUNCTIONS	25
7-1. Accessing Tech Menu For Maxstar 161 Models	25
SECTION 8 – MAINTENANCE AND TROUBLESHOOTING	26
8-1. Routine Maintenance	26
8-2. Meter Troubleshooting Displays	26
8-3. Troubleshooting	27
SECTION 9 – ELECTRICAL DIAGRAM	28

TABLE OF CONTENTS

SECTION 10 – HIGH FREQUENCY	29
10-1. Welding Processes Requiring High Frequency	29
10-2. Installation Showing Possible Sources Of HF Interference	29
10-3. Recommended Installation To Reduce HF Interference	30
SECTION 11 – SELECTING AND PREPARING A TUNGSTEN FOR DC OR AC WELDING WITH INVERTER MACHINES	31
11-1. Selecting Tungsten Electrode (Wear Clean Gloves To Prevent Contamination Of Tungsten)	31
11-2. Preparing Tungsten Electrode For DC Electrode Negative (DCEN) Welding Or AC Welding With Inverter Machines	31
SECTION 12 – STICK WELDING (SMAW) GUIDELINES	32
WARRANTY	
COMPLETE PARTS LIST – Available at www.MillerWelds.com	

SECTION 1 – SAFETY PRECAUTIONS - READ BEFORE USING

som 2018-01

 Protect yourself and others from injury — read, follow, and save these important safety precautions and operating instructions.

1-1. Symbol Usage



DANGER! – Indicates a hazardous situation which, if not avoided, will result in death or serious injury. The possible hazards are shown in the adjoining symbols or explained in the text.



Indicates a hazardous situation which, if not avoided, could result in death or serious injury. The possible hazards are shown in the adjoining symbols or explained in the text.

NOTICE – Indicates statements not related to personal injury.

 Indicates special instructions.



This group of symbols means Warning! Watch Out! ELECTRIC SHOCK, MOVING PARTS, and HOT PARTS hazards. Consult symbols and related instructions below for necessary actions to avoid the hazards.

1-2. Arc Welding Hazards



The symbols shown below are used throughout this manual to call attention to and identify possible hazards. When you see the symbol, watch out, and follow the related instructions to avoid the hazard. The safety information given below is only a summary of the more complete safety information found in the Safety Standards listed in Section 1-5. Read and follow all Safety Standards.



Only qualified persons should install, operate, maintain, and repair this equipment. A qualified person is defined as one who, by possession of a recognized degree, certificate, or professional standing, or who by extensive knowledge, training and experience, has successfully demonstrated ability to solve or resolve problems relating to the subject matter, the work, or the project and has received safety training to recognize and avoid the hazards involved.



During operation, keep everybody, especially children, away.



ELECTRIC SHOCK can kill.

Touching live electrical parts can cause fatal shocks or severe burns. The electrode and work circuit is electrically live whenever the output is on. The input power circuit and machine internal circuits are also live when power is on. In semiautomatic or automatic wire welding, the wire, wire reel, drive roll housing, and all metal parts touching the welding wire are electrically live. Incorrectly installed or improperly grounded equipment is a hazard.

- Do not touch live electrical parts.

- Wear dry, hole-free insulating gloves and body protection.
- Insulate yourself from work and ground using dry insulating mats or covers big enough to prevent any physical contact with the work or ground.
- Do not use AC weld output in damp, wet, or confined spaces, or if there is a danger of falling.
- Use AC output ONLY if required for the welding process.
- If AC output is required, use remote output control if present on unit.
- Additional safety precautions are required when any of the following electrically hazardous conditions are present: in damp locations or while wearing wet clothing; on metal structures such as floors, gratings, or scaffolds; when in cramped positions such as sitting, kneeling, or lying; or when there is a high risk of unavoidable or accidental contact with the workpiece or ground. For these conditions, use the following equipment in order presented: 1) a semiautomatic DC constant voltage (wire) welder, 2) a DC manual (stick) welder, or 3) an AC welder with reduced open-circuit voltage. In most situations, use of a DC, constant voltage wire welder is recommended. And, do not work alone!
- Disconnect input power or stop engine before installing or servicing this equipment. Lockout/tagout input power according to OSHA 29 CFR 1910.147 (see Safety Standards).

- Properly install, ground, and operate this equipment according to its Owner's Manual and national, state, and local codes.
- Always verify the supply ground – check and be sure that input power cord ground wire is properly connected to ground terminal in disconnect box or that cord plug is connected to a properly grounded receptacle outlet.
- When making input connections, attach proper grounding conductor first – double-check connections.
- Keep cords dry, free of oil and grease, and protected from hot metal and sparks.
- Frequently inspect input power cord and ground conductor for damage or bare wiring – replace immediately if damaged – bare wiring can kill.
- Turn off all equipment when not in use.
- Do not use worn, damaged, undersized, or repaired cables.
- Do not drape cables over your body.
- If earth grounding of the workpiece is required, ground it directly with a separate cable.
- Do not touch electrode if you are in contact with the work, ground, or another electrode from a different machine.
- Do not touch electrode holders connected to two welding machines at the same time since double open-circuit voltage will be present.
- Use only well-maintained equipment. Repair or replace damaged parts at once. Maintain unit according to manual.
- Wear a safety harness if working above floor level.
- Keep all panels and covers securely in place.
- Clamp work cable with good metal-to-metal contact to workpiece or worktable as near the weld as practical.
- Insulate work clamp when not connected to workpiece to prevent contact with any metal object.
- Do not connect more than one electrode or work cable to any single weld output terminal. Disconnect cable for process not in use.
- Use GFCI protection when operating auxiliary equipment in damp or wet locations.

SIGNIFICANT DC VOLTAGE exists in inverter welding power sources AFTER removal of input power.

- Turn off unit, disconnect input power, and discharge input capacitors according to instructions in Manual before touching any parts.



HOT PARTS can burn.

- Do not touch hot parts bare handed.
- Allow cooling period before working on equipment.
- To handle hot parts, use proper tools and/or wear heavy, insulated welding gloves and clothing to prevent burns.



FUMES AND GASES can be hazardous.

Welding produces fumes and gases. Breathing these fumes and gases can be hazardous to your health.

- Keep your head out of the fumes. Do not breathe the fumes.
- Ventilate the work area and/or use local forced ventilation at the arc to remove welding fumes and gases. The recommended way to determine adequate ventilation is to sample for the composition and quantity of fumes and gases to which personnel are exposed.
- If ventilation is poor, wear an approved air-supplied respirator.
- Read and understand the Safety Data Sheets (SDSs) and the manufacturer's instructions for adhesives, coatings, cleaners, consumables, coolants, degreasers, fluxes, and metals.
- Work in a confined space only if it is well ventilated, or while wearing an air-supplied respirator. Always have a trained watchperson nearby. Welding fumes and gases can displace air and lower the oxygen level causing injury or death. Be sure the breathing air is safe.
- Do not weld in locations near degreasing, cleaning, or spraying operations. The heat and rays of the arc can react with vapors to form highly toxic and irritating gases.
- Do not weld on coated metals, such as galvanized, lead, or cadmium plated steel, unless the coating is removed from the weld area, the area is well ventilated, and while wearing an air-supplied respirator. The coatings and any metals containing these elements can give off toxic fumes if welded.



ARC RAYS can burn eyes and skin.

Arc rays from the welding process produce intense visible and invisible (ultraviolet and infrared) rays that can burn eyes and skin. Sparks fly off from the weld.

- Wear an approved welding helmet fitted with a proper shade of filter lenses to protect your face and eyes from arc rays and sparks when welding or watching (see ANSI Z49.1 and Z87.1 listed in Safety Standards).
- Wear approved safety glasses with side shields under your helmet.
- Use protective screens or barriers to protect others from flash, glare and sparks; warn others not to watch the arc.
- Wear body protection made from durable, flame-resistant material (leather, heavy cotton, wool). Body protection includes oil-free clothing such as leather gloves, heavy shirt, cuffless trousers, high shoes, and a cap.



WELDING can cause fire or explosion.

Welding on closed containers, such as tanks, drums, or pipes, can cause them to blow up. Sparks can fly off from the welding arc. The flying sparks, hot workpiece, and hot equipment can cause fires and burns. Accidental contact of electrode to metal objects can cause sparks, explosion, overheating, or fire. Check and be sure the area is safe before doing any welding.

- Remove all flammables within 35 ft (10.7 m) of the welding arc. If this is not possible, tightly cover them with approved covers.
- Do not weld where flying sparks can strike flammable material.
- Protect yourself and others from flying sparks and hot metal.
- Be alert that welding sparks and hot materials from welding can easily go through small cracks and openings to adjacent areas.
- Watch for fire, and keep a fire extinguisher nearby.
- Be aware that welding on a ceiling, floor, bulkhead, or partition can cause fire on the hidden side.

- Do not cut or weld on tire rims or wheels. Tires can explode if heated. Repaired rims and wheels can fail. See OSHA 29 CFR 1910.177 listed in Safety Standards.
- Do not weld on containers that have held combustibles, or on closed containers such as tanks, drums, or pipes unless they are properly prepared according to AWS F4.1 and AWS A6.0 (see Safety Standards).
- Do not weld where the atmosphere can contain flammable dust, gas, or liquid vapors (such as gasoline).
- Connect work cable to the work as close to the welding area as practical to prevent welding current from traveling long, possibly unknown paths and causing electric shock, sparks, and fire hazards.
- Do not use welder to thaw frozen pipes.
- Remove stick electrode from holder or cut off welding wire at contact tip when not in use.
- Wear body protection made from durable, flame-resistant material (leather, heavy cotton, wool). Body protection includes oil-free clothing such as leather gloves, heavy shirt, cuffless trousers, high shoes, and a cap.
- Remove any combustibles, such as a butane lighter or matches, from your person before doing any welding.
- After completion of work, inspect area to ensure it is free of sparks, glowing embers, and flames.
- Use only correct fuses or circuit breakers. Do not oversize or bypass them.
- Follow requirements in OSHA 1910.252 (a) (2) (iv) and NFPA 51B for hot work and have a fire watcher and extinguisher nearby.
- Read and understand the Safety Data Sheets (SDSs) and the manufacturer's instructions for adhesives, coatings, cleaners, consumables, coolants, degreasers, fluxes, and metals.

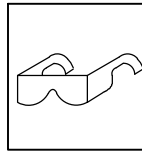

FLYING METAL or DIRT can injure eyes.

- Welding, chipping, wire brushing, and grinding cause sparks and flying metal. As welds cool, they can throw off slag.
- Wear approved safety glasses with side shields even under your welding helmet.



BUILDUP OF GAS can injure or kill.

- Shut off compressed gas supply when not in use.
- Always ventilate confined spaces or use approved air-supplied respirator.

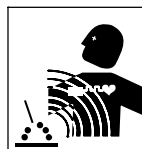

ELECTRIC AND MAGNETIC FIELDS (EMF) can affect Implanted Medical Devices.

- Wearers of Pacemakers and other Implanted Medical Devices should keep away.
- Implanted Medical Device wearers should consult their doctor and the device manufacturer before going near arc welding, spot welding, gouging, plasma arc cutting, or induction heating operations.

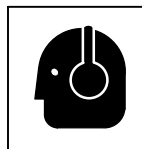

NOISE can damage hearing.

Noise from some processes or equipment can damage hearing.

- Wear approved ear protection if noise level is high.



CYLINDERS can explode if damaged.

Compressed gas cylinders contain gas under high pressure. If damaged, a cylinder can explode. Since gas cylinders are normally part of the welding process, be sure to treat them carefully.

- Protect compressed gas cylinders from excessive heat, mechanical shocks, physical damage, slag, open flames, sparks, and arcs.
- Install cylinders in an upright position by securing to a stationary support or cylinder rack to prevent falling or tipping.
- Keep cylinders away from any welding or other electrical circuits.
- Never drape a welding torch over a gas cylinder.
- Never allow a welding electrode to touch any cylinder.

- Never weld on a pressurized cylinder – explosion will result.
- Use only correct compressed gas cylinders, regulators, hoses, and fittings designed for the specific application; maintain them and associated parts in good condition.
- Turn face away from valve outlet when opening cylinder valve. Do not stand in front of or behind the regulator when opening the valve.
- Keep protective cap in place over valve except when cylinder is in use or connected for use.
- Use the proper equipment, correct procedures, and sufficient number of persons to lift, move, and transport cylinders.
- Read and follow instructions on compressed gas cylinders, associated equipment, and Compressed Gas Association (CGA) publication P-1 listed in Safety Standards.

1-3. Additional Symbols For Installation, Operation, And Maintenance



FIRE OR EXPLOSION hazard.

- Do not install or place unit on, over, or near combustible surfaces.
- Do not install unit near flammables.
- Do not overload building wiring – be sure power supply system is properly sized, rated, and protected to handle this unit.



FALLING EQUIPMENT can injure.

- Use lifting eye to lift unit only, NOT running gear, gas cylinders, or any other accessories.
- Use correct procedures and equipment of adequate capacity to lift and support unit.
- If using lift forks to move unit, be sure forks are long enough to extend beyond opposite side of unit.
- Keep equipment (cables and cords) away from moving vehicles when working from an aerial location.
- Follow the guidelines in the Applications Manual for the Revised NIOSH Lifting Equation (Publication No. 94-110) when manually lifting heavy parts or equipment.

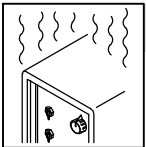

OVERUSE can cause OVERHEATING

- Allow cooling period; follow rated duty cycle.
- Reduce current or reduce duty cycle before starting to weld again.
- Do not block or filter airflow to unit.

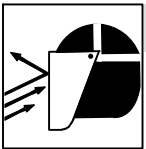

FLYING SPARKS can injure.

- Wear a face shield to protect eyes and face.
- Shape tungsten electrode only on grinder with proper guards in a safe location wearing proper face, hand, and body protection.
- Sparks can cause fires — keep flammables away.

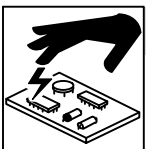

STATIC (ESD) can damage PC boards.

- Put on grounded wrist strap BEFORE handling boards or parts.
- Use proper static-proof bags and boxes to store, move, or ship PC boards.

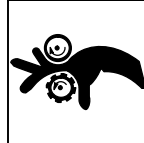

MOVING PARTS can injure.

- Keep away from moving parts.
- Keep away from pinch points such as drive rolls.



WELDING WIRE can injure.

- Do not press gun trigger until instructed to do so.
- Do not point gun toward any part of the body, other people, or any metal when threading welding wire.

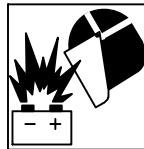

BATTERY EXPLOSION can injure.

- Do not use welder to charge batteries or jump start vehicles unless it has a battery charging feature designed for this purpose.



MOVING PARTS can injure.

- Keep away from moving parts such as fans.
- Keep all doors, panels, covers, and guards closed and securely in place.
- Have only qualified persons remove doors, panels, covers, or guards for maintenance and troubleshooting as necessary.
- Reinstall doors, panels, covers, or guards when maintenance is finished and before reconnecting input power.

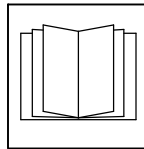

READ INSTRUCTIONS.

- Read and follow all labels and the Owner's Manual carefully before installing, operating, or servicing unit. Read the safety information at the beginning of the manual and in each section.
- Use only genuine replacement parts from the manufacturer.
- Perform installation, maintenance, and service according to the Owner's Manuals, industry standards, and national, state, and local codes.

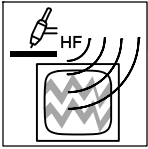

H.F. RADIATION can cause interference.

- High-frequency (H.F.) can interfere with radio navigation, safety services, computers, and communications equipment.
- Have only qualified persons familiar with electronic equipment perform this installation.
- The user is responsible for having a qualified electrician promptly correct any interference problem resulting from the installation.
- If notified by the FCC about interference, stop using the equipment at once.
- Have the installation regularly checked and maintained.
- Keep high-frequency source doors and panels tightly shut, keep spark gaps at correct setting, and use grounding and shielding to minimize the possibility of interference.

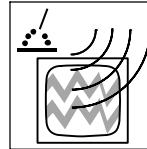

ARC WELDING can cause interference.

- Electromagnetic energy can interfere with sensitive electronic equipment such as computers and computer-driven equipment such as robots.
- Be sure all equipment in the welding area is electromagnetically compatible.
- To reduce possible interference, keep weld cables as short as possible, close together, and down low, such as on the floor.
- Locate welding operation 100 meters from any sensitive electronic equipment.
- Be sure this welding machine is installed and grounded according to this manual.
- If interference still occurs, the user must take extra measures such as moving the welding machine, using shielded cables, using line filters, or shielding the work area.

1-4. California Proposition 65 Warnings

⚠ WARNING: This product can expose you to chemicals including lead, which are known to the state of California to cause cancer and birth defects or other reproductive harm.

For more information, go to www.P65Warnings.ca.gov.

1-5. Principal Safety Standards

Safety in Welding, Cutting, and Allied Processes, ANSI Standard Z49.1, is available as a free download from the American Welding Society at <http://www.aws.org> or purchased from Global Engineering Documents (phone: 1-877-413-5184, website: www.global.ihs.com).

Safe Practices for the Preparation of Containers and Piping for Welding and Cutting, American Welding Society Standard AWS F4.1, from Global Engineering Documents (phone: 1-877-413-5184, website: www.global.ihs.com).

Safe Practices for Welding and Cutting Containers that have Held Combustibles, American Welding Society Standard AWS A6.0, from Global Engineering Documents (phone: 1-877-413-5184, website: www.global.ihs.com).

National Electrical Code, NFPA Standard 70, from National Fire Protection Association, Quincy, MA 02169 (phone: 1-800-344-3555, website: www.nfpa.org and www.sparky.org).

Safe Handling of Compressed Gases in Cylinders, CGA Pamphlet P-1, from Compressed Gas Association, 14501 George Carter Way, Suite 103, Chantilly, VA 20151 (phone: 703-788-2700, website: www.cganet.com).

Safety in Welding, Cutting, and Allied Processes, CSA Standard W117.2, from Canadian Standards Association, Standards Sales, 5060 Spectrum Way, Suite 100, Mississauga, Ontario, Canada L4W 5N5 (phone: 800-463-6727, website: www.csagroup.org).

Safe Practice For Occupational And Educational Eye And Face Protection, ANSI Standard Z87.1, from American National Standards Institute, 25 West 43rd Street, New York, NY 10036 (phone: 212-642-4900, website: www.ansi.org).

Standard for Fire Prevention During Welding, Cutting, and Other Hot Work, NFPA Standard 51B, from National Fire Protection Association, Quincy, MA 02169 (phone: 1-800-344-3555, website: www.nfpa.org).

OSHA, Occupational Safety and Health Standards for General Industry, Title 29, Code of Federal Regulations (CFR), Part 1910.177 Subpart N, Part 1910 Subpart Q, and Part 1926, Subpart J, from U.S. Government Printing Office, Superintendent of Documents, P.O. Box 371954, Pittsburgh, PA 15250-7954 (phone: 1-866-512-1800) (there are 10 OSHA Regional Offices—phone for Region 5, Chicago, is 312-353-2220, website: www.osha.gov).

Applications Manual for the Revised NIOSH Lifting Equation, The National Institute for Occupational Safety and Health (NIOSH), 1600 Clifton Rd, Atlanta, GA 30329-4027 (phone: 1-800-232-4636, website: www.cdc.gov/NIOSH).

1-6. EMF Information

Electric current flowing through any conductor causes localized electric and magnetic fields (EMF). The current from arc welding (and allied processes including spot welding, gouging, plasma arc cutting, and induction heating operations) creates an EMF field around the welding circuit. EMF fields can interfere with some medical implants, e.g. pacemakers. Protective measures for persons wearing medical implants have to be taken. For example, restrict access for passers-by or conduct individual risk assessment for welders. All welders should use the following procedures in order to minimize exposure to EMF fields from the welding circuit:

1. Keep cables close together by twisting or taping them, or using a cable cover.
2. Do not place your body between welding cables. Arrange cables to one side and away from the operator.
3. Do not coil or drape cables around your body.

4. Keep head and trunk as far away from the equipment in the welding circuit as possible.
5. Connect work clamp to workpiece as close to the weld as possible.
6. Do not work next to, sit or lean on the welding power source.
7. Do not weld whilst carrying the welding power source or wire feeder.

About Implanted Medical Devices:

Implanted Medical Device wearers should consult their doctor and the device manufacturer before performing or going near arc welding, spot welding, gouging, plasma arc cutting, or induction heating operations. If cleared by your doctor, then following the above procedures is recommended.

SECTION 2 – CONSIGNES DE SÉCURITÉ – LIRE AVANT UTILISATION

som_2018-01_fre

! Pour écarter les risques de blessure pour vous-même et pour autrui — lire, appliquer et ranger en lieu sûr ces consignes relatives aux précautions de sécurité et au mode opératoire.

2-1. Symboles utilisés



DANGER! – Indique une situation dangereuse qui si on l'évite pas peut donner la mort ou des blessures graves. Les dangers possibles sont montrés par les symboles joints ou sont expliqués dans le texte.



Indique une situation dangereuse qui si on l'évite pas peut donner la mort ou des blessures graves. Les dangers possibles sont montrés par les symboles joints ou sont expliqués dans le texte.

AVIS – Indique des déclarations pas en relation avec des blessures personnelles.

 Indique des instructions spécifiques.



Ce groupe de symboles veut dire Avertissement! Attention! DANGER DE CHOC ÉLECTRIQUE, PIÈCES EN MOUVEMENT, et PIÈCES CHAUDES. Consulter les symboles et les instructions ci-dessous y afférant pour les actions nécessaires afin d'éviter le danger.

2-2. Dangers relatifs au soudage à l'arc



Les symboles représentés ci-dessous sont utilisés dans ce manuel pour attirer l'attention et identifier les dangers possibles. En présence de l'un de ces symboles, prendre garde et suivre les instructions afférentes pour éviter tout risque. Les instructions en matière de sécurité indiquées ci-dessous ne constituent qu'un sommaire des instructions de sécurité plus complètes fournies dans les normes de sécurité énumérées dans la Section 2-5. Lire et observer toutes les normes de sécurité.



L'installation, l'utilisation, l'entretien et les réparations ne doivent être confiés qu'à des personnes qualifiées. Une personne qualifiée est définie comme celle qui, par la possession d'un diplôme reconnu, d'un certificat ou d'un statut professionnel, ou qui, par une connaissance, une formation et une expérience approfondies, a démontré avec succès sa capacité à résoudre les problèmes liés à la tâche, le travail ou le projet et a reçu une formation en sécurité afin de reconnaître et d'éviter les risques inhérents.



Pendant le fonctionnement, maintenir à distance toutes les personnes, notamment les enfants de l'appareil.



UNE DÉCHARGE ÉLECTRIQUE peut entraîner la mort.

Le contact d'organes électriques sous tension peut provoquer des accidents mortels ou des brûlures graves. Le circuit de l'électrode et de la pièce est sous tension lorsque le courant est délivré à la sortie. Le circuit d'alimentation et les circuits internes de la machine sont également sous tension lorsque l'alimentation est sur Marche. Dans le mode de soudage avec du fil, le fil, le dérouleur, le bloc de commande du rouleau et toutes les parties métalliques en contact avec le fil sont sous tension électrique. Un équipement installé ou mis à la terre de manière incorrecte ou impropre constitue un danger.

- Ne pas toucher aux pièces électriques sous tension.
- Porter des gants isolants et des vêtements de protection secs et sans trous.
- S'isoler de la pièce à couper et du sol en utilisant des housses ou des tapis assez grands afin d'éviter tout contact physique avec la pièce à couper ou le sol.
- Ne pas utiliser de sortie de soudage CA dans des zones humides ou confinées ou s'il y a un risque de chute.
- Se servir d'une source électrique à courant électrique UNIQUEMENT si le procédé de soudage le demande.
- Si l'utilisation d'une source électrique à courant électrique s'avère nécessaire, se servir de la fonction de télécommande si l'appareil en est équipé.
- D'autres consignes de sécurité sont nécessaires dans les conditions suivantes : risques électriques dans un environnement humide ou si l'on porte des vêtements mouillés ; sur des structures métalliques telles que sols, grilles ou échafaudages ; en position coincée comme assise, à genoux ou couchée ; ou s'il y a un risque élevé de contact inévitable ou accidentel avec la pièce à souder ou le sol. Dans ces conditions, utiliser les équipements suivants, dans l'ordre indiqué : 1) un poste à souder DC à tension constante (à fil), 2) un poste à souder DC manuel (électrode) ou 3) un poste à souder AC à tension à vide réduite. Dans la plupart des situations,

l'utilisation d'un poste à souder DC à fil à tension constante est recommandée. En outre, ne pas travailler seul !

- Couper l'alimentation ou arrêter le moteur avant de procéder à l'installation, à la réparation ou à l'entretien de l'appareil. Déverrouiller l'alimentation selon la norme OSHA 29 CFR 1910.147 (voir normes de sécurité).
- Installez, mettez à la terre et utilisez correctement cet équipement conformément à son Manuel d'Utilisation et aux réglementations nationales, gouvernementales et locales.
- Toujours vérifier la terre du cordon d'alimentation. Vérifier et s'assurer que le fil de terre du cordon d'alimentation est bien raccordé à la borne de terre du sectionneur ou que la fiche du cordon est raccordée à une prise correctement mise à la terre.
- En effectuant les raccordements d'entrée, fixer d'abord le conducteur de mise à la terre approprié et contre-vérifier les connexions.
- Les câbles doivent être exempts d'humidité, d'huile et de graisse; protégez-les contre les étincelles et les pièces métalliques chaudes.
- Vérifier fréquemment le cordon d'alimentation et le conducteur de mise à la terre afin de s'assurer qu'il n'est pas altéré ou dénudé -, le remplacer immédiatement s'il l'est -. Un fil dénudé peut entraîner la mort.
- L'équipement doit être hors tension lorsqu'il n'est pas utilisé.
- Ne pas utiliser des câbles usés, endommagés, de grosseur insuffisante ou mal épissés.
- Ne pas enrouler les câbles autour du corps.
- Si la pièce soudée doit être mise à la terre, le faire directement avec un câble distinct.
- Ne pas toucher l'électrode quand on est en contact avec la pièce, la terre ou une électrode provenant d'une autre machine.
- Ne pas toucher des porte électrodes connectés à deux machines en même temps à cause de la présence d'une tension à vide doublée.
- N'utiliser qu'un matériel en bon état. Réparer ou remplacer sur-le-champ les pièces endommagées. Entretenir l'appareil conformément à ce manuel.
- Porter un harnais de sécurité si l'on doit travailler au-dessus du sol.
- S'assurer que tous les panneaux et couvercles sont correctement en place.
- Fixer le câble de retour de façon à obtenir un bon contact métal-métal avec la pièce à souder ou la table de travail, le plus près possible de la soudure.
- Isoler la pince de masse quand pas mis à la pièce pour éviter le contact avec tout objet métallique.
- Ne pas raccorder plus d'une électrode ou plus d'un câble de masse à une même borne de sortie de soudage. Débrancher le câble pour le procédé non utilisé.
- Utiliser une protection différentielle lors de l'utilisation d'un équipement auxiliaire dans des endroits humides ou mouillés.

Il reste une TENSION DC NON NÉGLIGEABLE dans les sources de soudage onduleur UNE FOIS l'alimentation coupée.

- Éteignez l'unité, débranchez le courant électrique, et déchargez les condensateurs d'alimentation selon les instructions indiquées dans le manuel avant de toucher les pièces.



LES PIÈCES CHAUDES peuvent provoquer des brûlures.

- Ne pas toucher à mains nues les parties chaudes.
- Prévoir une période de refroidissement avant de travailler à l'équipement.

- Ne pas toucher aux pièces chaudes, utiliser les outils recommandés et porter des gants de soudage et des vêtements épais pour éviter les brûlures.



LES FUMÉES ET LES GAZ peuvent être dangereux.

Le soudage génère des fumées et des gaz. Leur inhalation peut être dangereux pour votre santé.

- Eloigner votre tête des fumées. Ne pas respirer les fumées.
- À l'intérieur, ventiler la zone et/ou utiliser une ventilation forcée au niveau de l'arc pour l'évacuation des fumées et des gaz de soudage. Pour déterminer la bonne ventilation, il est recommandé de procéder à un prélèvement pour la composition et la quantité de fumées et de gaz auxquelles est exposé le personnel.
- Si la ventilation est médiocre, porter un respirateur anti-vapeurs approuvé.
- Lire et comprendre les fiches de données de sécurité et les instructions du fabricant concernant les adhésifs, les revêtements, les nettoyants, les consommables, les produits de refroidissement, les dégraisseurs, les flux et les métaux.
- Travailler dans un espace fermé seulement s'il est bien ventilé ou en portant un respirateur à alimentation d'air. Demander toujours à un surveillant dûment formé de se tenir à proximité. Des fumées et des gaz de soudage peuvent déplacer l'air et abaisser le niveau d'oxygène provoquant des blessures ou des accidents mortels. S'assurer que l'air de respiration ne présente aucun danger.
- Ne pas souder dans des endroits situés à proximité d'opérations de dégraissage, de nettoyage ou de pulvérisation. La chaleur et les rayons de l'arc peuvent réagir en présence de vapeurs et former des gaz hautement toxiques et irritants.
- Ne pas souder des métaux munis d'un revêtement, tels que l'acier galvanisé, plaqué en plomb ou au cadmium à moins que le revêtement n'ait été enlevé dans la zone de soudure, que l'endroit soit bien ventilé, et en portant un respirateur à alimentation d'air. Les revêtements et tous les métaux renfermant ces éléments peuvent dégager des fumées toxiques en cas de soudage.



LES RAYONS DE L'ARC peuvent provoquer des brûlures dans les yeux et sur la peau.

Le rayonnement de l'arc du procédé de soudage génère des rayons visibles et invisibles intenses (ultraviolets et infrarouges) susceptibles de provoquer des brûlures dans les yeux et sur la peau. Des étincelles sont projetées pendant le soudage.

- Porter un casque de soudage approuvé muni de verres filtrants approprié pour protéger visage et yeux pour protéger votre visage et vos yeux pendant le soudage ou pour regarder (voir ANSI Z49.1 et Z87.1 énuméré dans les normes de sécurité).
- Porter des lunettes de sécurité avec écrans latéraux même sous votre casque.
- Avoir recours à des écrans protecteurs ou à des rideaux pour protéger les autres contre les rayonnements les éblouissements et les étincelles ; prévenir toute personne sur les lieux de ne pas regarder l'arc.
- Porter un équipement de protection pour le corps fait d'un matériau résistant et ignifuge (cuir, coton robuste, laine). La protection du corps comporte des vêtements sans huile comme par ex. des gants de cuir, une chemise solide, des pantalons sans revers, des chaussures hautes et une casquette.

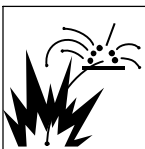

LE SOUDAGE peut provoquer un incendie ou une explosion.

Le soudage effectué sur des conteneurs fermés tels que des réservoirs, tambours ou des conduites peut provoquer leur éclatement. Des étincelles peuvent être projetées de l'arc de soudure. La projection d'étincelles, des pièces chaudes et des équipements chauds peut provoquer des incendies et des brûlures. Le contact accidentel de l'électrode avec des objets métalliques peut provoquer des étincelles, une explosion, un surchauffement ou un incendie. Avant de commencer le soudage, vérifier et s'assurer que l'endroit ne présente pas de danger.

- Déplacer toutes les substances inflammables à une distance de 10,7 m de l'arc de soudage. En cas d'impossibilité les recouvrir soigneusement avec des protections homologués.
- Ne pas souder dans un endroit où des étincelles peuvent tomber sur des substances inflammables.
- Se protéger et d'autres personnes de la projection d'étincelles et de métal chaud.
- Des étincelles et des matériaux chauds du soudage peuvent facilement passer dans d'autres zones en traversant de petites fissures et des ouvertures.
- Surveiller tout déclenchement d'incendie et tenir un extincteur à proximité.
- Le soudage effectué sur un plafond, plancher, paroi ou séparation peut déclencher un incendie de l'autre côté.
- Ne pas couper ou souder des jantes ou des roues. Les pneus peuvent exploser s'ils sont chauffés. Les jantes et les roues réparées peuvent défaillir. Voir OSHA 29 CFR 1910.177 énuméré dans les normes de sécurité.
- Ne pas effectuer le soudage sur des conteneurs fermés tels que des réservoirs, tambours, ou conduites, à moins qu'ils n'aient été préparés correctement conformément à AWS F4.1 et AWS A6.0 (voir les Normes de Sécurité).
- Ne pas souder là où l'air ambiant pourrait contenir des poussières, gaz ou émanations inflammables (vapeur d'essence, par exemple).
- Brancher le câble de masse sur la pièce la plus près possible de la zone de soudage pour éviter le transport du courant sur une longue distance par des chemins inconnus éventuels en provoquant des risques d'électrocution, d'étincelles et d'incendie.
- Ne pas utiliser le poste de soudage pour dégeler des conduites gelées.
- En cas de non utilisation, enlever la baguette d'électrode du porte-électrode ou couper le fil à la pointe de contact.
- Porter un équipement de protection pour le corps fait d'un matériau résistant et ignifuge (cuir, coton robuste, laine). La protection du corps comporte des vêtements sans huile comme par ex. des gants de cuir, une chemise solide, des pantalons sans revers, des chaussures hautes et une casquette.
- Avant de souder, retirer toute substance combustible de vos poches telles qu'un allumeur au butane ou des allumettes.
- Une fois le travail achevé, assurez-vous qu'il ne reste aucune trace d'étincelles incandescentes ni de flammes.
- Utiliser exclusivement des fusibles ou coupe-circuits appropriés. Ne pas augmenter leur puissance; ne pas les ponter.
- Suivre les recommandations dans OSHA 1910.252(a)(2)(iv) et NFPA 51B pour les travaux à chaud et avoir de la surveillance et un extincteur à proximité.
- Lire et comprendre les fiches de données de sécurité et les instructions du fabricant concernant les adhésifs, les revêtements, les nettoyants, les consommables, les produits de refroidissement, les dégraisseurs, les flux et les métaux.

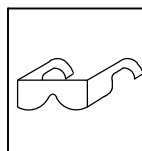

DES PIÈCES DE METAL ou DES SALETES peuvent provoquer des blessures dans les yeux.

- Le soudage, l'écaillage, le passage de la pièce à la brosse en fil de fer, et le meulage génèrent des étincelles et des particules métalliques volantes. Pendant la période de refroidissement des soudures, elles risquent de projeter du laitier.
- Porter des lunettes de sécurité avec écrans latéraux ou un écran facial.



LES ACCUMULATIONS DE GAZ risquent de provoquer des blessures ou même la mort.

- Fermer l'alimentation du gaz comprimé en cas de non utilisation.
- Veiller toujours à bien aérer les espaces confinés ou se servir d'un respirateur d'adduction d'air homologué.



Les CHAMPS ÉLECTROMAGNÉTIQUES (CEM) peuvent affecter les implants médicaux.

- Les porteurs de stimulateurs cardiaques et autres implants médicaux doivent rester à distance.
- Les porteurs d'implants médicaux doivent consulter leur médecin et le fabricant du dispositif avant de s'approcher de la zone où se déroule le soudage à l'arc, du soudage par points, du gougeage, de la découpe plasma ou une opération de chauffage par induction.



LE BRUIT peut endommager l'ouïe.

Le bruit des processus et des équipements peut affecter l'ouïe.

- Porter des protections approuvées pour les oreilles si le niveau sonore est trop élevé.



LES BOUTEILLES peuvent exploser si elles sont endommagées.

Les bouteilles de gaz comprimé contiennent du gaz sous haute pression. Si une bouteille est endommagée, elle peut exploser. Du fait que les bouteilles de gaz font normalement partie du procédé de soudage, les manipuler avec précaution.

- Protéger les bouteilles de gaz comprimé d'une chaleur excessive, des chocs mécaniques, des dommages physiques, du laitier, des flammes ouvertes, des étincelles et des arcs.
- Placer les bouteilles debout en les fixant dans un support stationnaire ou dans un porte-bouteilles pour les empêcher de tomber ou de se renverser.
- Tenir les bouteilles éloignées des circuits de soudage ou autres circuits électriques.
- Ne jamais placer une torche de soudage sur une bouteille à gaz.
- Une électrode de soudage ne doit jamais entrer en contact avec une bouteille.
- Ne jamais souder une bouteille pressurisée – risque d'explosion.
- Utiliser seulement des bouteilles de gaz comprimé, régulateurs, tuyaux et raccords convenables pour cette application spécifique; les maintenir ainsi que les éléments associés en bon état.
- Tourner le dos à la sortie de vanne lors de l'ouverture de la vanne de la bouteille. Ne pas se tenir devant ou derrière le régulateur lors de l'ouverture de la vanne.
- Le couvercle du détendeur doit toujours être en place, sauf lorsque la bouteille est utilisée ou qu'elle est reliée pour usage ultérieur.
- Utilisez les équipements corrects, les bonnes procédures et suffisamment de personnes pour soulever, déplacer et transporter les bouteilles.
- Lire et suivre les instructions sur les bouteilles de gaz comprimé, l'équipement connexe et le dépliant P-1 de la CGA (Compressed Gas Association) mentionné dans les principales normes de sécurité.

2-3. Dangers supplémentaires en relation avec l'installation, le fonctionnement et la maintenance

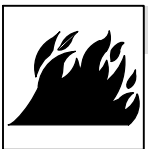

Risque D'INCENDIE OU D'EXPLOSION.

- Ne pas placer l'appareil sur, au-dessus ou à proximité de surfaces inflammables.
- Ne pas installer l'appareil à proximité de produits inflammables.
- Ne pas surcharger l'installation électrique – s'assurer que l'alimentation est correctement dimensionnée et protégée avant de mettre l'appareil en service.



LA CHUTE DE L'ÉQUIPEMENT peut provoquer des blessures.

- Utiliser l'anneau de levage uniquement pour soulever l'appareil, NON PAS les chariots, les bouteilles de gaz ou tout autre accessoire.
- Utilisez les procédures correctes et des équipements d'une capacité appropriée pour soulever et supporter l'appareil.
- En utilisant des fourches de levage pour déplacer l'unité, s'assurer que les fourches sont suffisamment longues pour dépasser du côté opposé de l'appareil.
- Tenir l'équipement (câbles et cordons) à distance des véhicules mobiles lors de toute opération en hauteur.
- Suivre les consignes du Manuel des applications pour l'équation de levage NIOSH révisée (Publication N°94-110) lors du levage manuel de pièces ou équipements lourds.

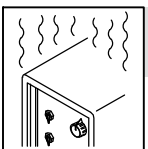

L'EMPLOI EXCESSIF peut SURCHAUFFER L'ÉQUIPEMENT.

- Prévoir une période de refroidissement ; respecter le cycle opératoire nominal.
- Réduire le courant ou le facteur de marche avant de poursuivre le soudage.
- Ne pas obstruer les passages d'air du poste.

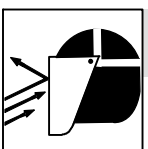

LES ÉTINCELLES PROJÉTÉES peuvent provoquer des blessures.

- Porter un écran facial pour protéger le visage et les yeux.
- Affûter l'électrode au tungstène uniquement à la meuleuse dotée de protecteurs. Cette manœuvre est à exécuter dans un endroit sûr lorsque l'on porte l'équipement homologué de protection du visage, des mains et du corps.
- Les étincelles risquent de causer un incendie – éloigner toute substance inflammable.

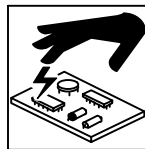

LES CHARGES ÉLECTROSTATIQUES peuvent endommager les circuits imprimés.

- Établir la connexion avec la barrette de terre avant de manipuler des cartes ou des pièces.
- Utiliser des pochettes et des boîtes antistatiques pour stocker, déplacer ou expédier des cartes de circuits imprimés.

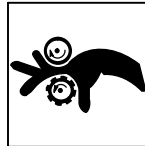

Les PIÈCES MOBILES peuvent causer des blessures.

- Ne pas s'approcher des organes mobiles.
- Ne pas s'approcher des points de coincement tels que des rouleaux de commande.



LES FILS DE SOUDAGE peuvent provoquer des blessures.

- Ne pas appuyer sur la gâchette avant d'en avoir reçu l'instruction.
- Ne pas diriger le pistolet vers soi, d'autres personnes ou toute pièce mécanique en engageant le fil de soudage.

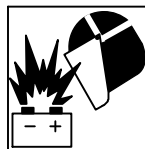

L'EXPLOSION DE LA BATTERIE peut provoquer des blessures.

- Ne pas utiliser l'appareil de soudage pour charger des batteries ou faire démarrer des véhicules à l'aide de câbles de démarrage, sauf si l'appareil dispose d'une fonctionnalité de charge de batterie destinée à cet usage.



Les PIÈCES MOBILES peuvent causer des blessures.

- S'abstenir de toucher des organes mobiles tels que des ventilateurs.
- Maintenir fermés et verrouillés les portes, panneaux, recouvrements et dispositifs de protection.
- Lorsque cela est nécessaire pour des travaux d'entretien et de dépannage, faire retirer les portes, panneaux, recouvrements ou dispositifs de protection uniquement par du personnel qualifié.
- Remettre les portes, panneaux, recouvrements ou dispositifs de protection quand l'entretien est terminé et avant de rebrancher l'alimentation électrique.

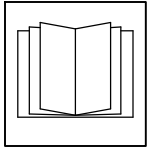

LIRE LES INSTRUCTIONS.

- Lire et appliquer les instructions sur les étiquettes et le Mode d'emploi avant l'installation, l'utilisation ou l'entretien de l'appareil. Lire les informations de sécurité au début du manuel et dans chaque section.

- N'utiliser que les pièces de rechange recommandées par le constructeur.
- Effectuer l'installation, l'entretien et toute intervention selon les manuels d'utilisateurs, les normes nationales, provinciales et de l'industrie, ainsi que les codes municipaux.

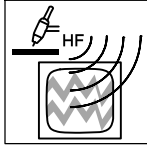

LE RAYONNEMENT HAUTE FRÉQUENCE (H.F.) risque de provoquer des interférences.

- Le rayonnement haute fréquence (H.F.) peut provoquer des interférences avec les équipements de radio-navigation et de communication, les services de sécurité et les ordinateurs.
- Demander seulement à des personnes qualifiées familiarisées avec des équipements électroniques de faire fonctionner l'installation.
- L'utilisateur est tenu de faire corriger rapidement par un électricien qualifié les interférences résultant de l'installation.
- Si le FCC signale des interférences, arrêter immédiatement l'appareil.

- Effectuer régulièrement le contrôle et l'entretien de l'installation.
- Maintenir soigneusement fermés les portes et les panneaux des sources de haute fréquence, maintenir les éclateurs à une distance correcte et utiliser une terre et un blindage pour réduire les interférences éventuelles.



LE SOUDAGE À L'ARC risque de provoquer des interférences.

- L'énergie électromagnétique risque de provoquer des interférences pour l'équipement électronique sensible tel que les ordinateurs et l'équipement commandé par ordinateur tel que les robots.
- Veiller à ce que tout l'équipement de la zone de soudage soit compatible électromagnétiquement.
- Pour réduire la possibilité d'interférence, maintenir les câbles de soudage aussi courts que possible, les grouper, et les poser aussi bas que possible (ex. par terre).
- Veiller à souder à une distance de 100 mètres de tout équipement électronique sensible.
- Veiller à ce que ce poste de soudage soit posé et mis à la terre conformément à ce mode d'emploi.
- En cas d'interférences après avoir pris les mesures précédentes, il incombe à l'utilisateur de prendre des mesures supplémentaires telles que le déplacement du poste, l'utilisation de câbles blindés, l'utilisation de filtres de ligne ou la pose de protecteurs dans la zone de travail.

2-4. Proposition californienne 65 Avertissements

⚠ AVERTISSEMENT : ce produit peut vous exposer à des produits chimiques tels que le plomb, reconnus par l'État de Californie comme cancérigènes et sources de malformations ou d'autres troubles de la reproduction.

Pour plus d'informations, consulter www.P65Warnings.ca.gov.

2-5. Principales normes de sécurité

Safety in Welding, Cutting, and Allied Processes, ANSI Standard Z49.1, is available as a free download from the American Welding Society at <http://www.aws.org> or purchased from Global Engineering Documents (phone: 1-877-413-5184, website: www.global.ihc.com).

Safe Practices for the Preparation of Containers and Piping for Welding and Cutting, American Welding Society Standard AWS F4.1, from Global Engineering Documents (phone: 1-877-413-5184, website: www.global.ihc.com).

Safe Practices for Welding and Cutting Containers that have Held Combustibles, American Welding Society Standard AWS A6.0, from Global Engineering Documents (phone: 1-877-413-5184, website: www.global.ihc.com).

National Electrical Code, NFPA Standard 70, from National Fire Protection Association, Quincy, MA 02169 (phone: 1-800-344-3555, website: www.nfpa.org and www.sparky.org).

Safe Handling of Compressed Gases in Cylinders, CGA Pamphlet P-1, from Compressed Gas Association, 14501 George Carter Way, Suite 103, Chantilly, VA 20151 (phone: 703-788-2700, website: www.cganet.com).

Safety in Welding, Cutting, and Allied Processes, CSA Standard W117.2, from Canadian Standards Association, Standards Sales, 5060 Spec-

trum Way, Suite 100, Mississauga, Ontario, Canada L4W 5N5 (phone: 800-463-6727, website: www.csagroup.org).

Safe Practice For Occupational And Educational Eye And Face Protection, ANSI Standard Z87.1, from American National Standards Institute, 25 West 43rd Street, New York, NY 10036 (phone: 212-642-4900, website: www.ansi.org).

Standard for Fire Prevention During Welding, Cutting, and Other Hot Work, NFPA Standard 51B, from National Fire Protection Association, Quincy, MA 02169 (phone: 1-800-344-3555, website: www.nfpa.org).

OSHA, Occupational Safety and Health Standards for General Industry, Title 29, Code of Federal Regulations (CFR), Part 1910.177 Subpart N, Part 1910 Subpart Q, and Part 1926, Subpart J, from U.S. Government Printing Office, Superintendent of Documents, P.O. Box 371954, Pittsburgh, PA 15250-7954 (phone: 1-866-512-1800) (there are 10 OSHA Regional Offices—phone for Region 5, Chicago, is 312-353-2220, website: www.osha.gov).

Applications Manual for the Revised NIOSH Lifting Equation, The National Institute for Occupational Safety and Health (NIOSH), 1600 Clifton Rd, Atlanta, GA 30329-4027 (phone: 1-800-232-4636, website: www.cdc.gov/NIOSH).

2-6. Informations relatives aux CEM

Le courant électrique qui traverse tout conducteur génère des champs électromagnétiques (CEM) à certains endroits. Le courant issu d'un soudage à l'arc (et de procédés connexes, y compris le soudage par points, le gougeage, le découpage plasma et les opérations de chauffage par induction) crée un champ électromagnétique (CEM) autour du circuit de soudage. Les champs électromagnétiques produits peuvent causer interférence à certains implants médicaux, p. ex. les stimulateurs cardiaques. Des mesures de protection pour les porteurs d'implants médicaux doivent être prises: Limiter par exemple tout accès aux passants ou procéder à une évaluation des risques individuels pour les soudeurs. Tous les soudeurs doivent appliquer les procédures suivantes pour minimiser l'exposition aux CEM provenant du circuit de soudage:

1. Rassembler les câbles en les torsadant ou en les attachant avec du ruban adhésif ou avec une housse.
2. Ne pas se tenir au milieu des câbles de soudage. Disposer les

câbles d'un côté et à distance de l'opérateur.

3. Ne pas courber et ne pas entourer les câbles autour de votre corps.
4. Maintenir la tête et le torse aussi loin que possible du matériel du circuit de soudage.
5. Connecter la pince sur la pièce aussi près que possible de la soudure.
6. Ne pas travailler à proximité d'une source de soudage, ni s'asseoir ou se pencher dessus.
7. Ne pas souder tout en portant la source de soudage ou le dévidoir.





En ce qui concerne les implants médicaux :

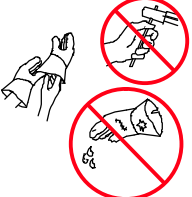
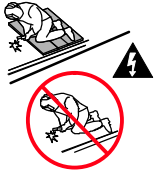
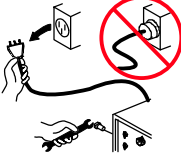

Les porteurs d'implants doivent d'abord consulter leur médecin avant de s'approcher des opérations de soudage à l'arc, de soudage par points, de gougeage, du coupage plasma ou de chauffage par induction. Si le médecin approuve, il est recommandé de suivre les procédures précédentes.

SECTION 3 – DEFINITIONS

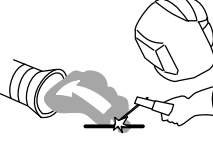
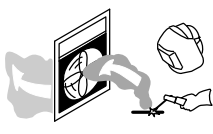
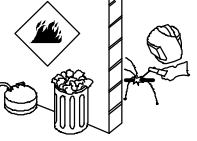



3-1. Additional Safety Symbols And Definitions

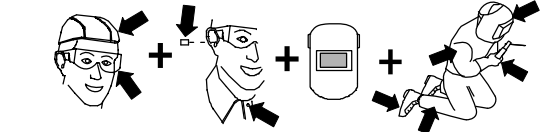
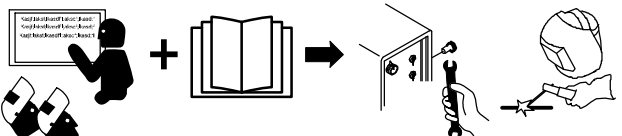



 Some symbols are found only on CE products.



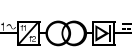

	<p>Warning! Watch Out! There are possible hazards as shown by the symbols.</p> <p style="text-align: right;">Safe1 2012-05</p>
	<p>Wear dry insulating gloves. Do not touch electrode with bare hand. Do not wear wet or damaged gloves.</p> <p style="text-align: right;">Safe2 2017-04</p>
	<p>Protect yourself from electric shock by insulating yourself from work and ground.</p> <p style="text-align: right;">Safe3 2017-04</p>
	<p>Disconnect input plug or power before working on machine.</p> <p style="text-align: right;">Safe5 2017-04</p>
	<p>Keep your head out of the fumes.</p> <p style="text-align: right;">Safe6 2017-04</p>
	<p>Use forced ventilation or local exhaust to remove the fumes.</p> <p style="text-align: right;">Safe8 2012-05</p>
	<p>Use ventilating fan to remove fumes.</p> <p style="text-align: right;">Safe10 2012-05</p>
	<p>Keep flammables away from welding. Do not weld near flammables.</p> <p style="text-align: right;">Safe12 2012-05</p>
	<p>Welding sparks can cause fires. Have a fire extinguisher nearby, and have a watchperson ready to use it.</p> <p style="text-align: right;">Safe14 2012-05</p>

	<p>Do not weld on drums or any closed containers.</p> <p style="text-align: right;">Safe16 2017-04</p>
	<p>Do not remove or paint over (cover) the label.</p> <p style="text-align: right;">Safe20 2017-04</p>
	<p>Do not discard product (where applicable) with general waste. Reuse or recycle Waste Electrical and Electronic Equipment (WEEE) by disposing at a designated collection facility. Contact your local recycling office or your local distributor for further information.</p> <p style="text-align: right;">Safe37 2017-04</p>
	<p>Wear hat and safety glasses. Use ear protection and button shirt collar. Use welding helmet with correct shade of filter. Wear complete body protection.</p> <p style="text-align: right;">Safe38 2012-05</p>
	<p>Become trained and read the instructions before working on the machine or welding.</p> <p style="text-align: right;">Safe40 2012-05</p>

3-2. Miscellaneous Symbols And Definitions

A	Amperage
V	Voltage
Hz	Hertz
	Output
	Gas Input
	Increase/Decrease Of Quantity
%	Percent
	Alternating Current
I_{1eff}	Maximum Effective Supply Current
	Menu

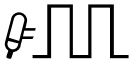
-	Negative
	On/Off (Standby)
	Suitable For Areas Of Increased Shock Hazard
	Shielded Metal Arc Welding (SMAW)
+	Positive
	Single Phase Static Frequency Converter-Transformer-Rectifier
	Direct Current
	Line Connection
X	Duty Cycle

U₁	Primary Voltage
U₂	Conventional Load Voltage
U₀	Rated No Load Voltage OCV
I_{1max}	Rated Maximum Supply Current
I₂	Rated Welding Current
	Remote
	Arc Striking With Contact (LiftArc)
	Gas Tungsten Arc Welding (GTAW)
	TIG (GTAW) Pulse
	Arc Striking Without Contact (HF and Impulse)

SECTION 4 – SPECIFICATIONS

4-1. Serial Number And Rating Label Location

The serial number is located on the bottom, and rating information is located on the back of the machine. Use the rating labels to determine input power requirements and/or rated output. For future reference, write serial number in space provided on back cover of this manual.

4-2. Specifications

☞ This equipment will deliver rated output at an ambient air temperature up to 104 °F (40 °C).

☞ Do not use information in unit specifications table to determine electrical service requirements. See Sections 5-2 thru 5-5 for information on connecting input power.

Input Power Single-Phase AC	Rated Welding Output	Welding Am- perage Range	Max OCV DC (Uo)	Rated Peak Starting Voltage (Up)	Amperes Input At Rated Load Output, 50/60Hz, Single-Phase	KVA @ Duty Cycle	KW
120 Volts Stick	90A @ 23.6 Volts DC, 30% Duty Cycle	20 – 90A	48V *12-16	**15 KV	23.16	2.78	2.76
	75A @ 23 Volts DC, 60% Duty Cycle				18.82	2.26	2.22
	60A @ 22.4 Volts DC, 100% Duty Cycle				14.68	1.75	1.71
120 Volts TIG	130A @ 15.2 Volts DC, 30% Duty Cycle	5 – 130A	48V *12-16	**15 KV	22.6	2.73	2.70
	110A @ 14.4 Volts DC, 60% Duty Cycle				18.67	2.25	2.20
	90A @ 13.6 Volts DC, 100% Duty Cycle				14.61	1.75	1.70
240 Volts Stick	160A @ 26.4 Volts DC, 20% Duty Cycle	20 – 160A	48V *12-16	**15 KV	22.55	5.41	5.25
	130A @ 25.2 Volts DC, 60% Duty Cycle				17.60	4.24	4.09
	110A @ 24.4 Volts DC, 100% Duty Cycle				14.31	3.43	3.30
240 Volts TIG	160A @ 16.4 Volts DC, 20% Duty Cycle	5 – 160A	48V *12-16	**15 KV	15.05	3.62	3.49
	130A @ 15.4 Volts DC, 60% Duty Cycle				11.41	2.73	2.60
	110A @ 14.4 Volts DC, 100% Duty Cycle				9.35	2.24	2.12

*Sense Voltage For Stick And TIG Lift Arc™

** Arc Striking Device Is Designed For Manual Guided Operations

4-3. Dimensions And Weight

Weight	13 lb (8.9 kg)
Dimensions	L = 13.5 in. (342.9 mm), W = 5.6 in. (142.2 mm), H = 10.3 in. (261.6 mm)

4-4. Environmental Specifications

A. IP Rating

IP Rating
<p>IP23</p> <p>This equipment is designed for outdoor use.</p> <p style="text-align: right;">IP23 2017-02</p>

B. Information On Electromagnetic Compatibility (EMC)

<p>⚠ This Class A equipment is not intended for use in residential locations where the electrical power is provided by the public low-voltage supply system. There can be potential difficulties in ensuring electromagnetic compatibility in those locations, due to conducted as well as radiated disturbances.</p> <p>This equipment complies with IEC 61000-3-11 and IEC 61000-3-12.</p> <p style="text-align: right;">ce-emc 4 2014-07</p>
--

C. Temperature Specifications

Operating Temperature Range*	Storage/Transportation Temperature Range
-40 to 104 °F (-40 to 40°C)	-40 to 158 °F (-40 to 70°C)
*Output is derated at temperatures above 104°F (40°C).	Temp_2016-07

4-5. Duty Cycle And Overheating For Maxstar 161S Models

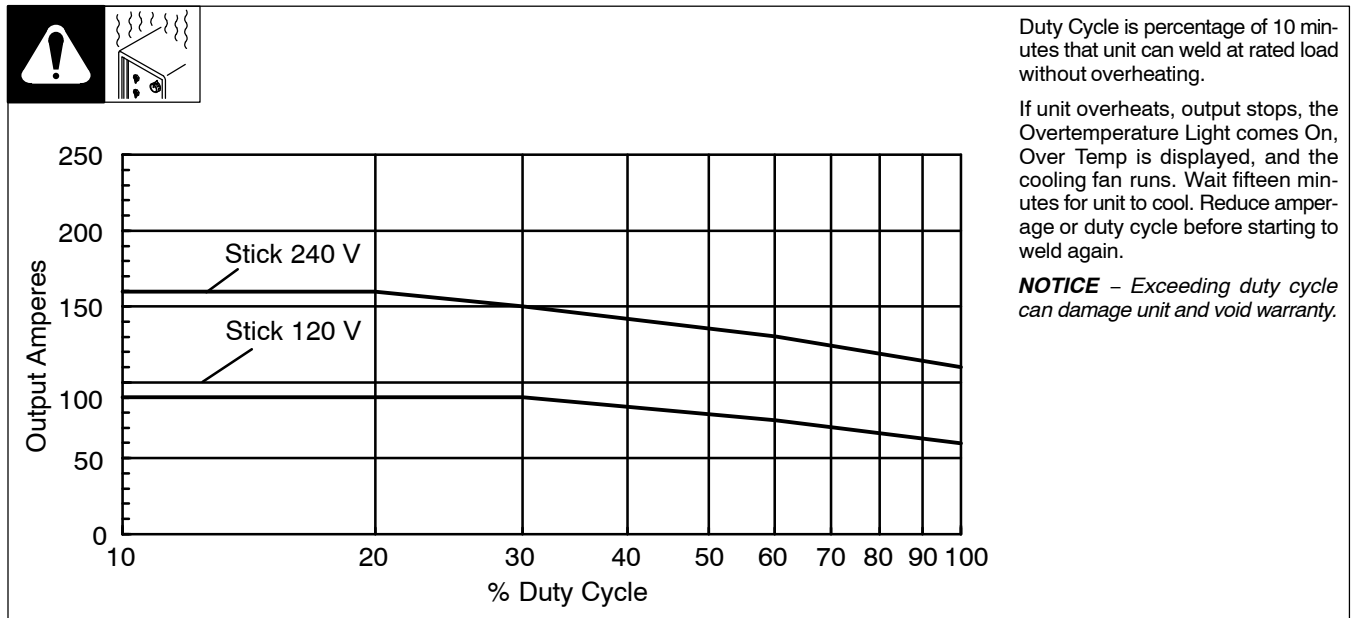

4-5. Duty Cycle And Overheating For Maxstar 161STL And STH Models



Duty Cycle is percentage of 10 minutes that unit can weld at rated load without overheating.

If unit overheats, output stops, the Overtemperature Light comes On, Over Temp is displayed, and the cooling fan runs. Wait fifteen minutes for unit to cool. Reduce amperage or duty cycle before starting to weld again.

NOTICE – Exceeding duty cycle can damage unit and void warranty.

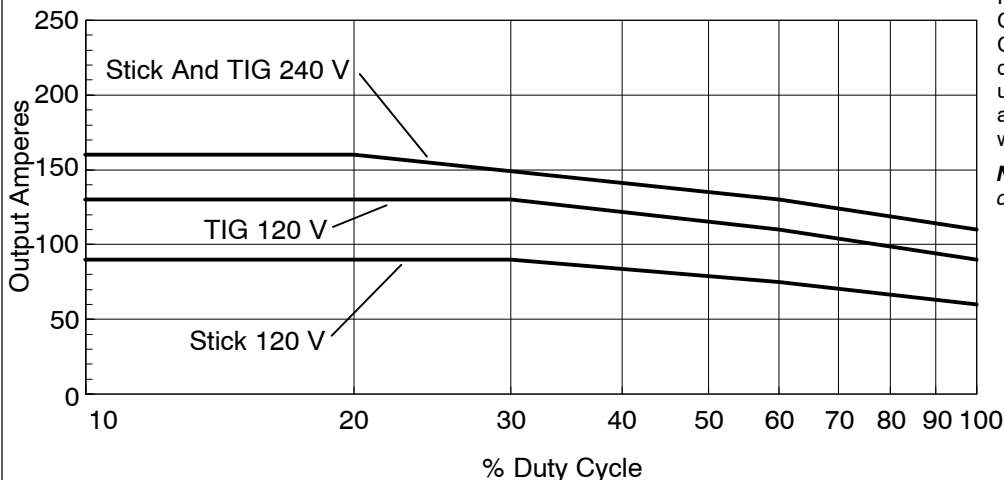

4-6. Static Characteristics

The static (output) characteristics of the welding power source can be described as *drooping* during the SMAW and GTAW processes. Static characteristics are also affected by control settings (including software), electrode, shielding gas, weldment material, and other factors. Contact the factory for specific information on the static characteristics of the welding power source.

4-7. Remote 6 Receptacle Information (STL And STH Models Only)

 Ref. 805575-A	REMOTE 6	Socket	Socket Information
	15 VOLTS DC OUTPUT CONTACTOR		1
2			Contact closure to 1 completes contactor control circuit and enables output when Lift-Arc TIG remote is selected.
REMOTE OUTPUT CONTROL		3	Output to remote control; +10 volts DC output to remote control.
		4	0 to +10 volts DC input command signal from remote control.
		5	Remote control circuit common.
CHASSIS		6	Chassis common.

5-2. Electrical Service Guide

The Auto-Line™ circuitry in this unit automatically adapts the power source to the primary voltage being applied. Check input voltage available at site. This unit can be connected to any input power between 120–240 VAC without removing the cover to relink the power source.

Actual input voltage should not exceed ± 10% of indicated required input voltage. If actual input voltage is outside of this range, output may not be available.

⚠ Failure to follow these electrical service guide recommendations could create an electric shock or fire hazard. These recommendations are for a dedicated circuit sized for the rated output and duty cycle of the welding power source.

In dedicated circuit installations, the National Electrical Code (NEC) allows the receptacle or conductor rating to be less than the rating of the circuit protection device. All components of the circuit must be physically compatible. See NEC articles 210.21, 630.11, and 630.12.

	50/60 Hz 1-Phase	50/60 Hz 1-Phase
Input Voltage (V)	120	240
Rated Maximum Supply Current I_{1max} (A)	A 15 or 20 ampere individual branch circuit protected by time-delay fuses or circuit breaker is required. See Section 5-4.	22.6
Maximum Effective Supply Current I_{1eff} (A)		14.3
Max Recommended Standard Fuse Rating In Amperes ¹		25
Time-Delay Fuses ²		
Normal Operating Fuses ³		30
Min Input Conductor Size In AWG (mm ²) ⁴	14 (2.5)	
Max Recommended Input Conductor Length In Feet (Meters)	53 (16)	
Min Grounding Conductor Size In AWG (mm ²) ⁴	14 (2.5)	

Reference: 2017 National Electrical Code (NEC) (including article 630)

1 If a circuit breaker is used in place of a fuse, choose a circuit breaker with time-current curves comparable to the recommended fuse.

2 “Time-Delay” fuses are UL class “RK5” . See UL 248.

3 “Normal Operating” (general purpose - no intentional delay) fuses are UL class “K5” (up to and including 60 amps), and UL class “H” (65 amps and above).

4 Conductor data in this section specifies conductor size (excluding flexible cord or cable) between the panelboard and the equipment per NEC Table 310.15(B)(16) and is based on allowable ampacities of insulated copper conductors having a temperature rating of 167°F (75°C) with not more than three single current-carrying conductors in a raceway. If a flexible cord or cable is used, minimum conductor size may increase. See NEC Table 400.5(A) for flexible cord and cable requirements.

5-3. Input Power Extension Cord Data

⚠ Use extension cord only for temporary wiring. Remove extension cord immediately after completing the project.

Input 17 2018-11

Cord Type	Minimum Conductor Size	Number of Conductors	Maximum Cord Length
Heavy Duty (Hard Usage)	12 AWG (4 mm ²)	3	50 ft (15 m)

Read OSHA Standard 1910.334 for more information on the use of cord and plug connected equipment.
Read National Electrical Code (NEC) Article 590 for more information on temporary wiring.

5-4. Connecting 120 VAC Input Power

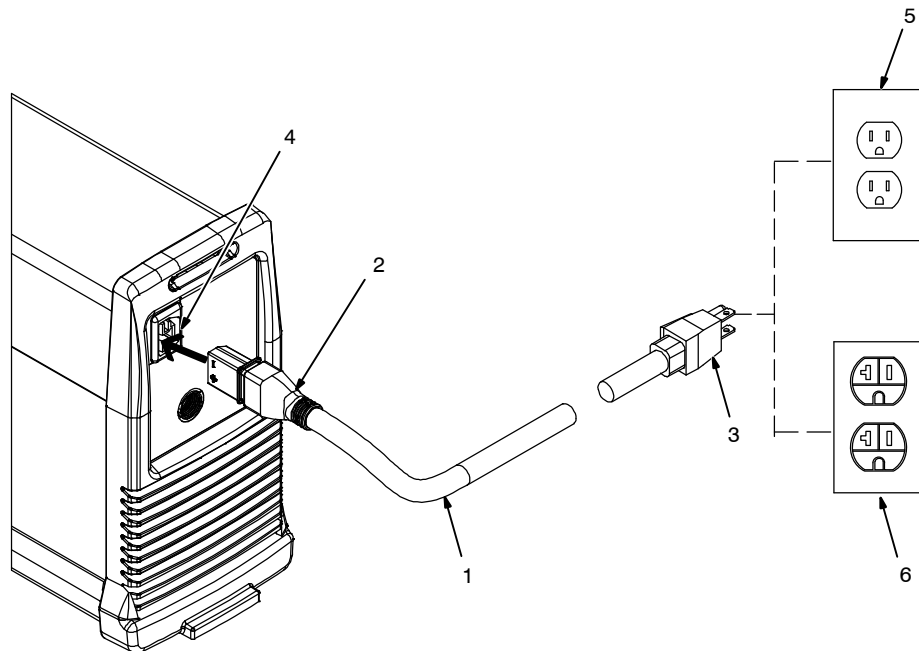

- ⚠ Do not move or operate unit where it could tip.
- ⚠ Installation must meet all National and Local Codes – have only qualified persons make this installation.
- ⚠ Do not use power cord to lift or carry welding power source.
- ⚠ Special installation may be required where gasoline or volatile liquids are present – see NEC Article 511 or CEC Section 20.
- ⚠ Remove power cord from receptacle on the back of the welding power source before transporting or storing the unit. Failure to remove power cord may result in damage to the cord.
- ⚠ Do not wrap cord around welding power source or cord may be damaged.

ℹ The Auto-Line circuitry in this unit automatically links the power source to the primary voltage being applied, either 120 or 240 VAC.

NOTICE – Do Not modify the power cord. The power cord plugs will work with standard NEMA receptacles. Use only the power cords supplied with this unit. Modifying the power cord(s) and/or plugs, or using cords not intended for use with this product will void warranty.

For 120 volts AC input power, a 15 or 20 ampere individual branch circuit protected by time-delay fuses or circuit breaker is required. For 240 volts AC input power, see Section 5-5.

1 Power Cord 120 VAC

120 VAC cord with NEMA type 5 -15P plug and SDG plug.

2 Plug - SDG

3 Plug - NEMA Type 5 - 15P

4 Receptacle - SDG

5 Receptacle - NEMA Type 5-15R

6 Receptacle - NEMA Type 6 - 20R

Connect plug (3) to receptacle (5 or 6).

5-5. Connecting 1-Phase Input Power For 240 VAC

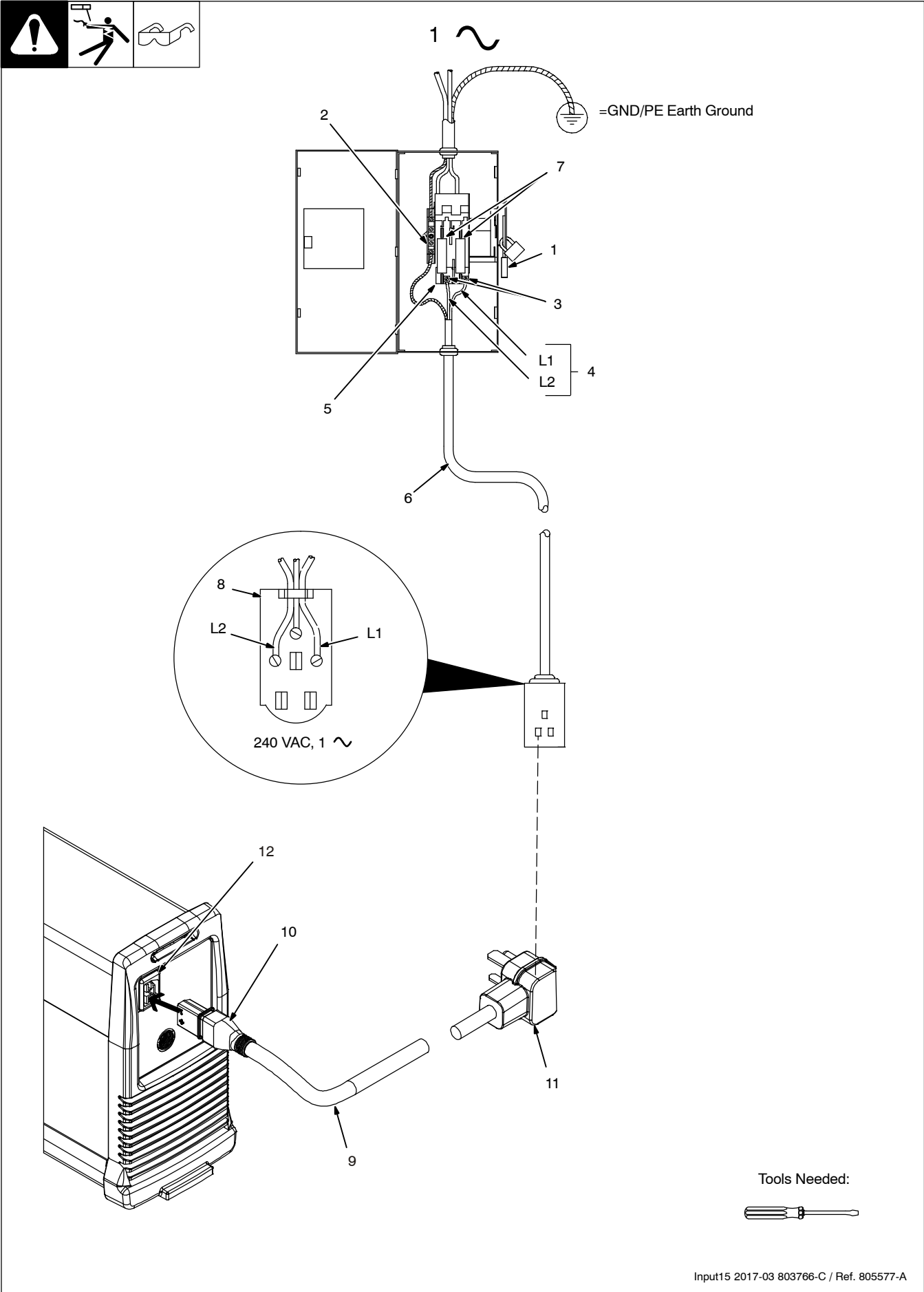

5-6. Shoulder And Handle Strap Installation



A. Shoulder Strap Installation

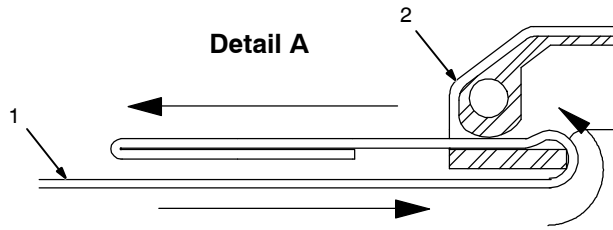

Detail A is Critical!
Insert strap through cam buckle
As Shown

Strap Buckle Assembly

- 1 Strap
- 2 Cam Buckle

If necessary, before attaching shoulder/handle strap to power source, assemble strap/buckle as shown.

B. Handle Strap Installation

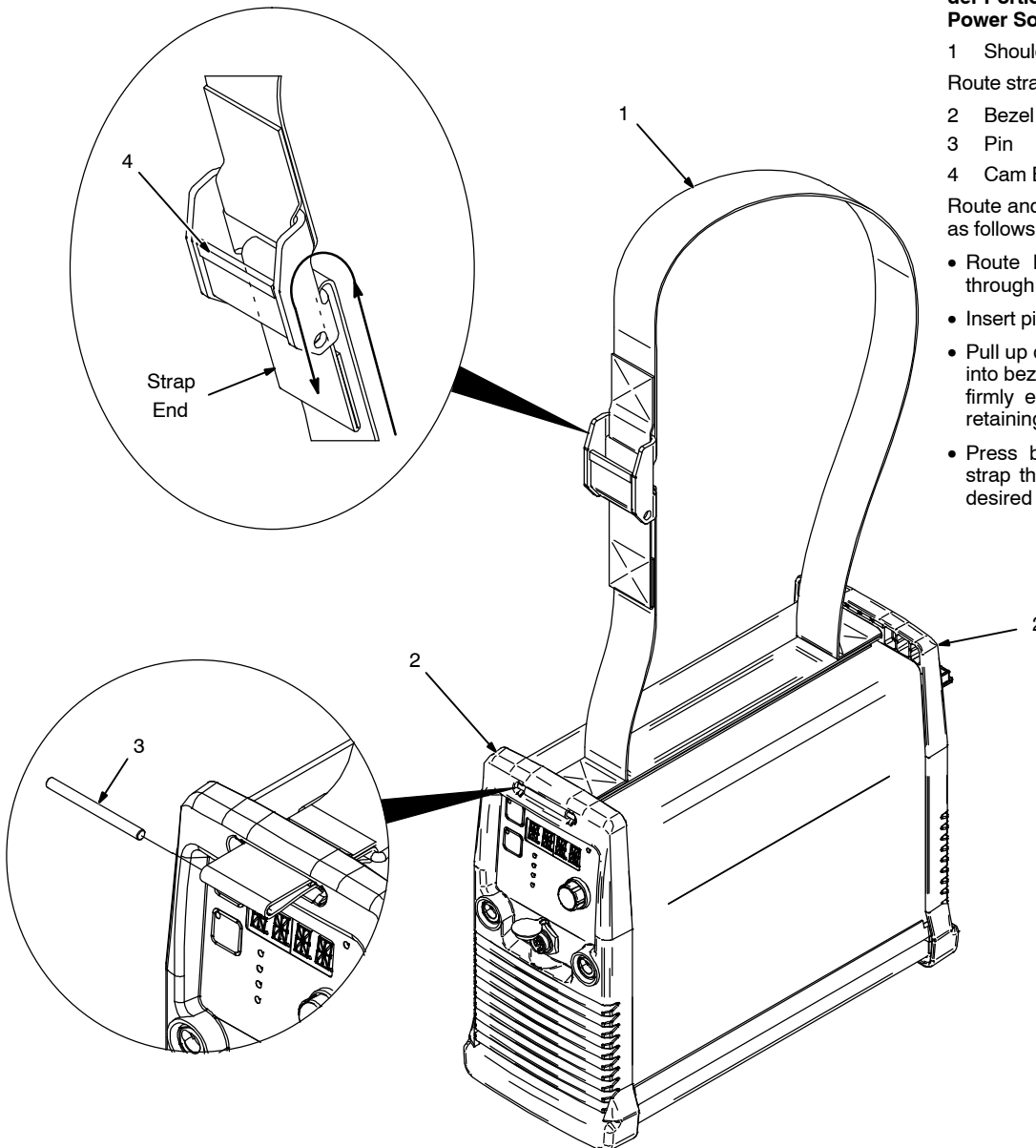

Installing And Securing Shoulder Portion Of Strap To Welding Power Source

- 1 Shoulder/Handle Strap
- 2 Bezel (Front And Rear)
- 3 Pin
- 4 Cam Buckle Lever

Route and secure shoulder strap as follows:

- Route looped ends of strap through openings in bezels.
- Insert pins through strap loops.
- Pull up on straps to pull pins up into bezel openings. Pull straps firmly enough to seat pins in retaining slots in openings.
- Press buckle lever, and slide strap through buckle to obtain desired length. Release lever.

SECTION 6 – OPERATION

6-1. Front Panel Controls And Gas Connection

Ref. 803375-A / 273310-A

☐ Represents a message that displays, scrolls and repeats.

☐ Represents a particle message that flashes, displays the remainder of the message, and then repeats.

<p>1 Ready Light (LED) Light comes on approximately two seconds after power switch is placed in On (I) position if Lift-Arc On or Stick has been selected. If TIG Impulse is selected, ready light comes on only after output is enabled. The light indicates that the unit is energized and ready for welding. A flashing light indicates unit is not ready, or that there is a functional error.</p> <p>☐ The fan motor is thermostatically controlled.</p>	<p>2 Amperage Adjustment Control This control adjusts welding amperage.</p> <p>3 Process Select Button See Section 6-3.</p> <p>4 Positive Weld Output Receptacle For Stick welding, connect electrode cable to this receptacle. For TIG welding, connect work cable to this receptacle.</p> <p>5 Negative Weld Output Receptacle For Stick welding, connect work cable to this receptacle. For TIG welding, connect torch cable to this receptacle.</p> <p>6 Remote Receptacle For TIG Impulse or Lift-Arc TIG, output may be adjusted from min to max of the front panel setting with a remote control.</p>	<p>7 Power Switch Place switch in On or Off position as needed.</p> <p>8 Parameter Display</p> <p>9 Gas Fitting Fittings have 5/8-18 right-hand threads (3/8-19 BSPP on CE units).</p> <p>10 Cylinder Valve Open valve slightly so gas flow blows dirt from valve. Close valve.</p> <p>11 Regulator/Flowmeter</p> <p>12 Flow Adjust Typical flow rate is 15 cubic feet per hour (7.1 liters per minute) at a maximum of 90 psi (621 kPa). Connect customer supplied gas hose between regulator/flowmeter and gas fitting .</p>
--	---	---

6-2. Process Selection (STL Model Only)

<p>1 Process Selector Button Use control to select required welding process. Press Button until LED for desired process is illuminated.</p>	<p>2 Lift Arc™ Start When selected, a TIG arc starting method in which the electrode must come in contact with the workpiece to initiate an arc is activated (see Section 6-5).</p>
<p>3 Stick (SMAW) When selected, Adaptive Hot Start, Stick Stuck, and DIG circuitry are energized.</p>	<p>4 Stick 6010 (SMAW) When selected, Adaptive Hot Start, Stick Stuck, and DIG circuitry are energized. Parameters are optimized to run a 6010 Stick electrode.</p>

6-3. Process Selection (STH Model Only)

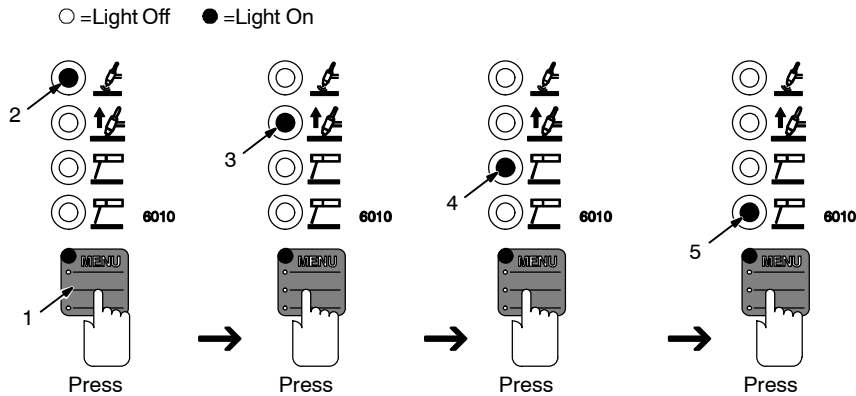
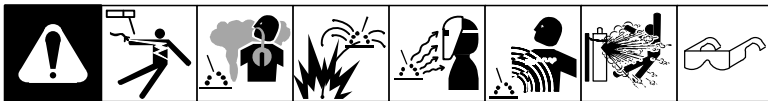

1 Process Selector Button

Use control to select required welding process. Press Button until light (LED) for desired process is illuminated.

2 TIG Impulse Start

When selected, an impulse HF arc starting method is activated (see Section 6-5).

3 Lift-Arc Start

When selected, a TIG arc starting method in which the electrode must come in contact with the workpiece to initiate an arc is activated (see Section 6-5).

4 Stick (SMAW)

When selected, Adaptive Hot Start, Stick Stuck and DIG circuitry are energized.

5 Stick 6010 (SMAW)

When selected, Adaptive Hot Start, Stick Stuck, and DIG circuitry are energized. Parameters are optimized to run a 6010 Stick electrode.

6-4. Process Selection (S Model Only)



○ =Light Off ● =Light On

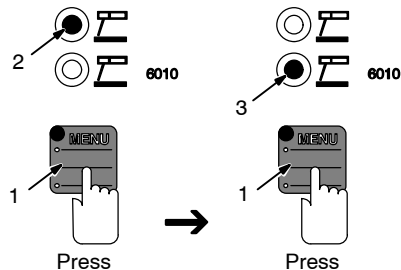

1 Process Selector Button

Use control to select required welding process. Press Button until LED for desired process is illuminated.

2 Stick (SMAW)

When selected, Adaptive Hot Start, Stick Stuck, and DIG circuitry are energized.

3 Stick 6010 (SMAW)

When selected, Adaptive Hot Start, Stick Stuck, and DIG circuitry are energized. Parameters are optimized to run a 6010 Stick electrode.

6-5. Lift-Arc And TIG Impulse Start Procedures



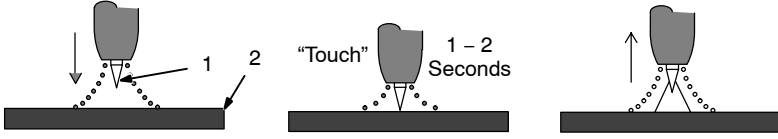

Do NOT Strike Like A Match!

Lift-Arc Start

- 1 TIG Electrode
- 2 Workpiece

Touch tungsten electrode to workpiece, **hold for 1-2 seconds**, slowly lift electrode, and an arc forms.

Open-circuit voltage maybe present before electrode touches workpiece.

TIG Impulse

High frequency starts arc when output is enabled without making contact with the workpiece. High frequency turns off when arc is started.

Pictorials show Lift-Arc start method – do not use this method for TIG Impulse starts.

6-6. Accessing Control Panel Menu: TIG-HF (STH Model Only)



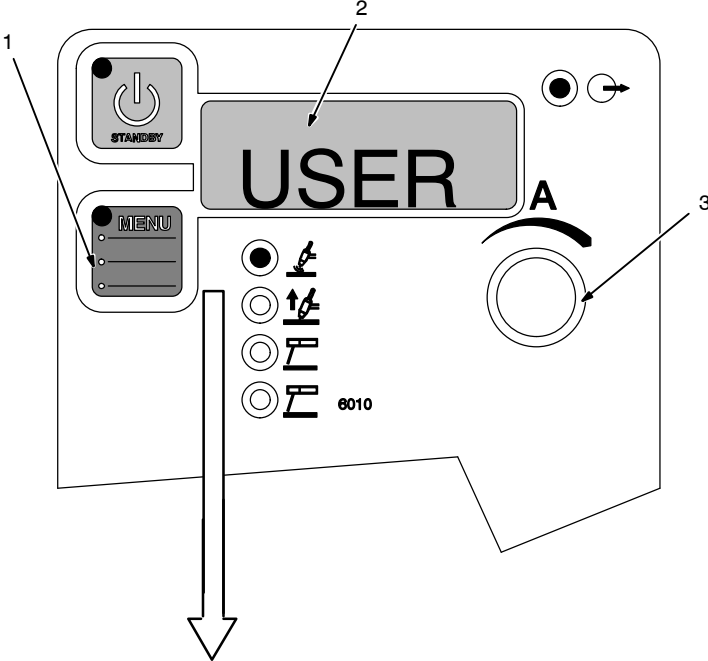

- 1 Menu Button

While in the High Frequency (HF) process, press and hold Menu button for approximately two seconds to access Machine Configuration menus. Use Menu button to cycle through parameters that can be set.

- 2 Parameter Display
- 3 Encoder

Rotate Encoder to adjust parameter setting.

Trigger Mode Selection:

[REMOTE STD] Remote Standard

Typically used with a remote foot or hand control. REMOTE STD requires a maintained contact closure to enable weld output. Amperage can be controlled with a remote potentiometer, or it can be set at the control panel.

[REMOTE HOLD] Remote Hold

Remote control required. Allows the operator to weld without holding the trigger closed. To start the weld, operator presses and releases trigger. To stop the weld, the operator again presses and releases the trigger. In this mode, only the output contactor is controlled by the remote control. Amperage must be set on the control panel. See section 7-1 for Auto Crater function.

[PPS] Pulse Control:

Reduces heat input to minimize distortion and increase travel speed. Set PPS (pulse per second). The range is OFF–150 PPS. Background Amperage and Peak Amperage are not adjustable. Background Amperage equals 25% of Peak Amperage. Peak Amperage Time equals 40%.

6-7. Accessing Control Panel Menu: Lift-Arc TIG (STH And STL Models Only)

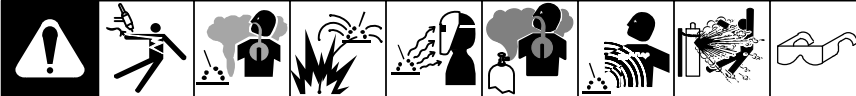

1 Menu Button

While in the Lift-Arc process, press and hold Menu button for approximately two seconds to access Machine Configuration menus. Use Menu button to cycle through parameters that can be set.

2 Parameter Display

3 Encoder

Rotate Encoder to adjust parameter setting.

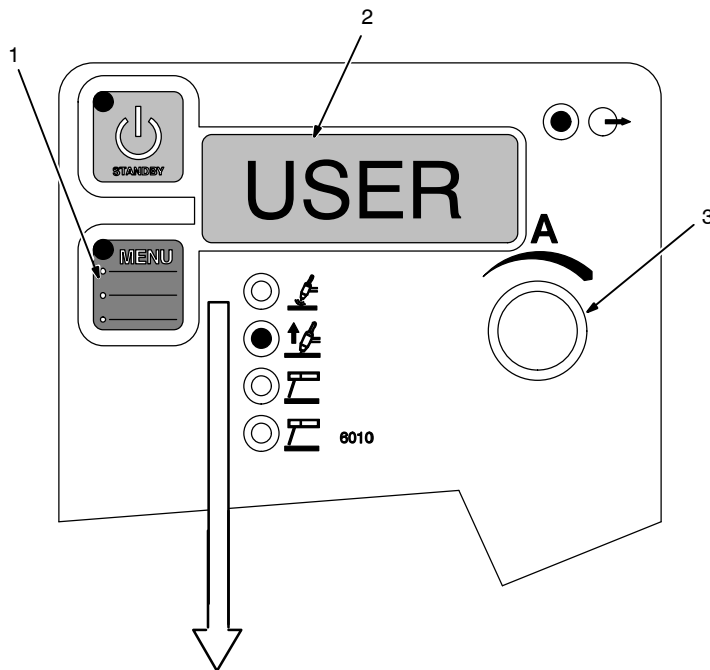

REMOTE STD

REMOTE HOLD

PPS → OFF

Trigger Mode Selection:

[REMOTE STD] Remote Standard

Typically used with a remote foot or hand control. REMOTE STD requires a maintained contact closure to enable weld output. Amperage can be controlled with a remote potentiometer, or it can be set at the control panel.

[OUTPUT ON] Output on (Lift only)

[REMOTE HOLD] Remote Hold

Remote control required. Allows the operator to weld without holding the trigger closed. To start the weld, the operator presses and releases the trigger. To stop the weld, the operator again presses and releases the trigger. In Remote Hold mode only the output contactor is controlled by the remote control. Amperage must be set on the control panel. See section 7-1 for Auto Crater function.

[PPS] Pulse Control: (STH Model Only)

Reduces heat input to minimize distortion and increase travel speed. Set PPS (pulse per second). The range is OFF-150 PPS. Background Amperage and Peak Amperage are not adjustable. Background Amperage equals 25% of Peak Amperage. Peak Amperage Time equals 40%.

SECTION 7 – ADVANCED MENU FUNCTIONS

7-1. Accessing Tech Menu For Maxstar 161 Models

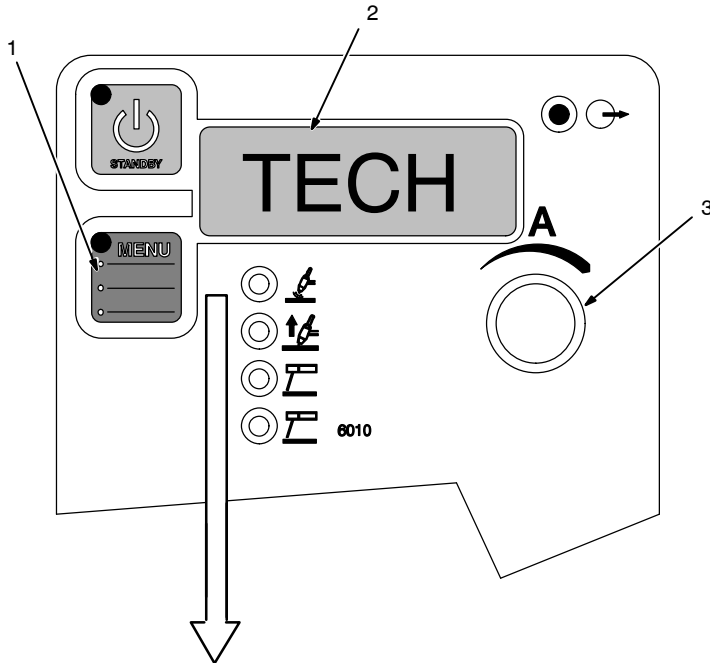
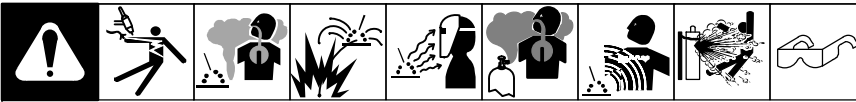

1 Menu Button

Press and hold Menu button for approximately four seconds to scroll past User Menu to Tech Menu. Use Menu button to cycle through parameters that can be set.

2 Parameter Display

3 Encoder

Rotate Encoder to adjust parameter setting.

To exit Tech Menu, press and hold menu button approximately one second, or turn power off.

Settings in the Tech Menu are global, meaning they may pertain to all or some of the process.

ARC/TCY

[ARC/TCY] Arc Timer: Monitors hours, minutes, and cycles of valid arc on. To view, rotate encoder. To reset, rotate encoder until [RESET] [YES] is displayed. Press Menu button to display [RESET] [Done]. Displays turn to [000] [000].

STICK/OCV → NORM

[STICK/OCV] > [NORM] Open-Circuit Voltage: Allows user to select between Normal [NORM] and Low [Low] open-circuit voltage. Selecting Low reduces open-circuit voltage in stick process to between 12 and 16 volts.

STUC → OFF

[STUC] > [OFF] Stick Stuck: Detects if the electrode is stuck or shorted to the workpiece. Turns weld output off to aid in freeing the electrode. To turn on, rotate encoder. Not recommended for large diameter electrodes.

CRTR → OFF

[CRTR] > [OFF] Auto Crater: In TIG Remote Hold trigger mode, Auto Crater ramps weld current down at a fixed rate to end the weld cycle. To turn on, rotate the encoder. Push and release torch trigger to end weld current and start Auto Crater.

FACTORY RESET











[FACTORY RESET] Machine Reset: Resets all machine values back to factory defaults. To reset, turn encoder to [RESET] [YES]. Then press Menu button. [RESET] [DONE] will be displayed when the reset is complete and factory defaults have been restored.

SOFTWARE NUMBER

[SOFTWARE NUMBER] Software Number: Software number and revision will be displayed.

SECTION 8 – MAINTENANCE AND TROUBLESHOOTING

8-1. Routine Maintenance

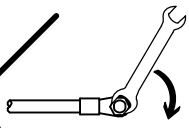
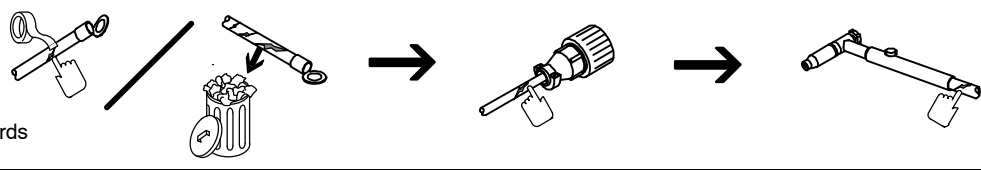
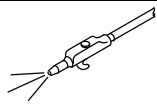
   		⚠ Disconnect power before maintaining.  <i>Maintain more often during severe conditions.</i>	
		✓ = Check ◇ = Change ● = Clean Δ = Repair ☆ = Replace * To be done by Factory Authorized Service Agent	
Every 3 Months	 		 
	✓ ☆ Labels	✓ ☆ Gas Hoses	● Weld Terminals
Every 3 Months			
	✓ Δ ☆ Cables And Cords		
Every 6 Months			
	⚠ Do not remove case when blowing out inside of unit. Blow out inside. Direct airflow through front and back louvers.		
	●: During heavy service, clean monthly.		

8-2. Meter Troubleshooting Displays



 All directions are in reference to the front of the unit. All circuitry referred to is located inside the unit.

 Typical meter display may be in several segments. Each segment is shown for two seconds, and then scrolls to the remaining segments of the display. The message then repeats itself.

Release Trigger Error:

- **[RELEASE TRIGGER]**

Remote 6 receptacle contactor control (Pins 1–2) must be opened before proceeding.

- **[See O.M. ERROR 7.2.3]**

Serial Communication to the user interface card board has been lost. To clear error, turn off power. If error does not clear or happens frequently, contact a Factory Authorized Service Agent.

Over Temperature Errors:

- **[OVER TEMPERATURE]**

Over temperature condition in the primary inverter circuitry has occurred. Error will clear after the temperature has reached acceptable levels. Or, over temperature of the weld output circuitry has occurred. Error will clear after the temperature has reached acceptable levels.

Temperature Sensor Failure:

- **[See O.M. ERROR 3.4.1]**

Indicates a short or open in the thermal protection circuitry located in the primary inverter circuitry of the unit. Contact a Factory Authorized Service Agent if this display is shown.

- **[See O.M. ERROR 3.3.1]**

Indicates a short or open in the thermal protection circuitry located in the weld output circuitry of the unit. Contact a Factory Authorized Service Agent if this display is shown.

Latching Errors:

- **[See O.M. ERROR 1.3.4]**

Secondary clamp voltage too high. Straighten out or shorten weld cables. If this does not correct the problem, contact a Factory Authorized Service Agent.

- **[See O.M. ERROR 1.4.0]**

Indicates failure of primary input circuitry. Check input power and if error does not clear contact a Factory Authorized Service Agent.

- **[See O.M. ERROR 1.4.3]**

Input current too high. To clear error, remove power from unit, then reconnect power to unit. If this error does not clear or happens frequently, contact a Factory Authorized Service Agent.

Not Valid Error:

- **[Not Valid]**

Indicates a non-allowable set-up on the front panel.

8-3. Troubleshooting



Trouble	Remedy
No weld output; unit completely inoperative.	Place line disconnect switch in On position (see Sections 5-4 or 5-5).
	Check and replace line fuse(s), if necessary (see Sections 5-4 or 5-5).
	Check for proper input power connections (see Sections 5-4 or 5-5).
No weld output; unit on.	Check, repair, or replace remote control.
	Have Factory Authorized Service Agent check unit.
Unit provides only maximum or minimum weld output.	Make sure Material Amperage control is in proper position (see Section 6-1).
	Have Factory Authorized Service Agent check unit.
Erratic or improper weld output.	Lay weld cables out straight, do not leave weld cables coiled.
	Check position of Process Selector switch (see Section Figure 6-1).
	Check position of Amperage control (see Section 6-1).
No control of weld output.	Make sure Material Amperage control is in proper position (see Section 6-1).
Lack of high frequency; difficulty in starting GTAW arc.	Be sure torch cable is not close to any grounded metal.
	Check cables and torch for cracked insulation or bad connections. Repair or replace.
Wandering arc – poor control of direction of arc.	Reduce gas flow rate (see Section 6-1).
	Properly prepare tungsten (see Section 11-2).
Tungsten electrode oxidizing and not remaining bright after conclusion of weld.	Shield weld zone from drafts.
	Check and tighten all gas fittings.
	Properly prepare tungsten (see Section 11-2).
Fan not operating.	Unit equipped with Fan-On-Demand™. Fans run only when necessary. Unit equipped with circuitry to protect against overheating.
No weld output; fan does not run.	Place line disconnect switch in On position (see Sections 5-4 or 5-5).
	Check and replace line fuse(s), if necessary, or reset circuit breaker (see Sections 5-4 or 5-5).
	Check for proper input power connections (see Sections 5-4 or 5-5).
No weld output; fan on.	Check connection to remote control receptacle (see Section 4-7).
	Check remote control (see remote control Owner's Manual).
	Unit overheated. Allow unit to cool (see Section 4-5).
Fan not operating; weld output available.	Check for and remove anything blocking fan movement.
	Have Factory Authorized Service Agent check fan motor.
Error message [See O.M. ERROR 3.4.1] is displayed.	Contact a Factory Authorized Service Agent.
Error message [See O.M. ERROR 3.3.1] is displayed.	Contact a Factory Authorized Service Agent.
Error message [See O.M. ERROR 7.2.3] is displayed.	Contact a Factory Authorized Service Agent.
Error message [See O.M. ERROR 1.4.0] is displayed.	Contact a Factory Authorized Service Agent.
Error message [See O.M. ERROR 1.4.3] is displayed.	Contact a Factory Authorized Service Agent.
Error message [See O.M. ERROR 1.3.4] is displayed.	Contact a Factory Authorized Service Agent.

SECTION 9 - ELECTRICAL DIAGRAM

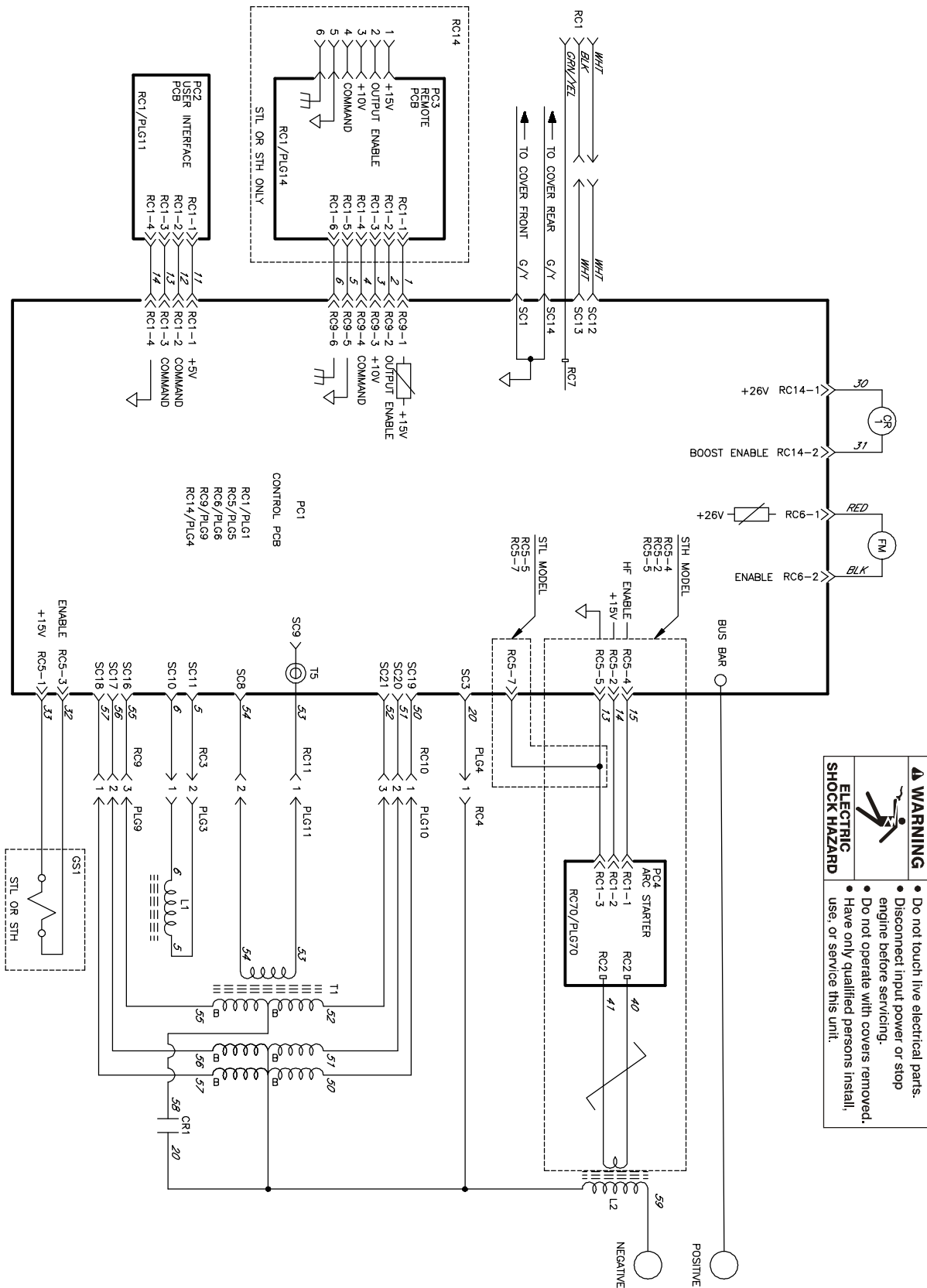

WARNING

ELECTRIC SHOCK HAZARD

- Do not touch live electrical parts.
- Disconnect input power or stop engine before servicing.
- Do not operate with covers removed.
- Have only qualified persons install, use, or service this unit.

Figure 9-1. Circuit Diagram For Welding Power Source

SECTION 10 – HIGH FREQUENCY

10-1. Welding Processes Requiring High Frequency



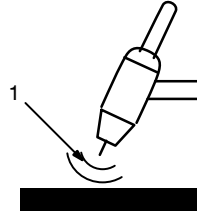

TIG

1 High-Frequency Voltage
TIG – helps arc jump air gap between torch and workpiece and/or stabilize the arc.

high_freq 2018-01

10-2. Installation Showing Possible Sources Of HF Interference



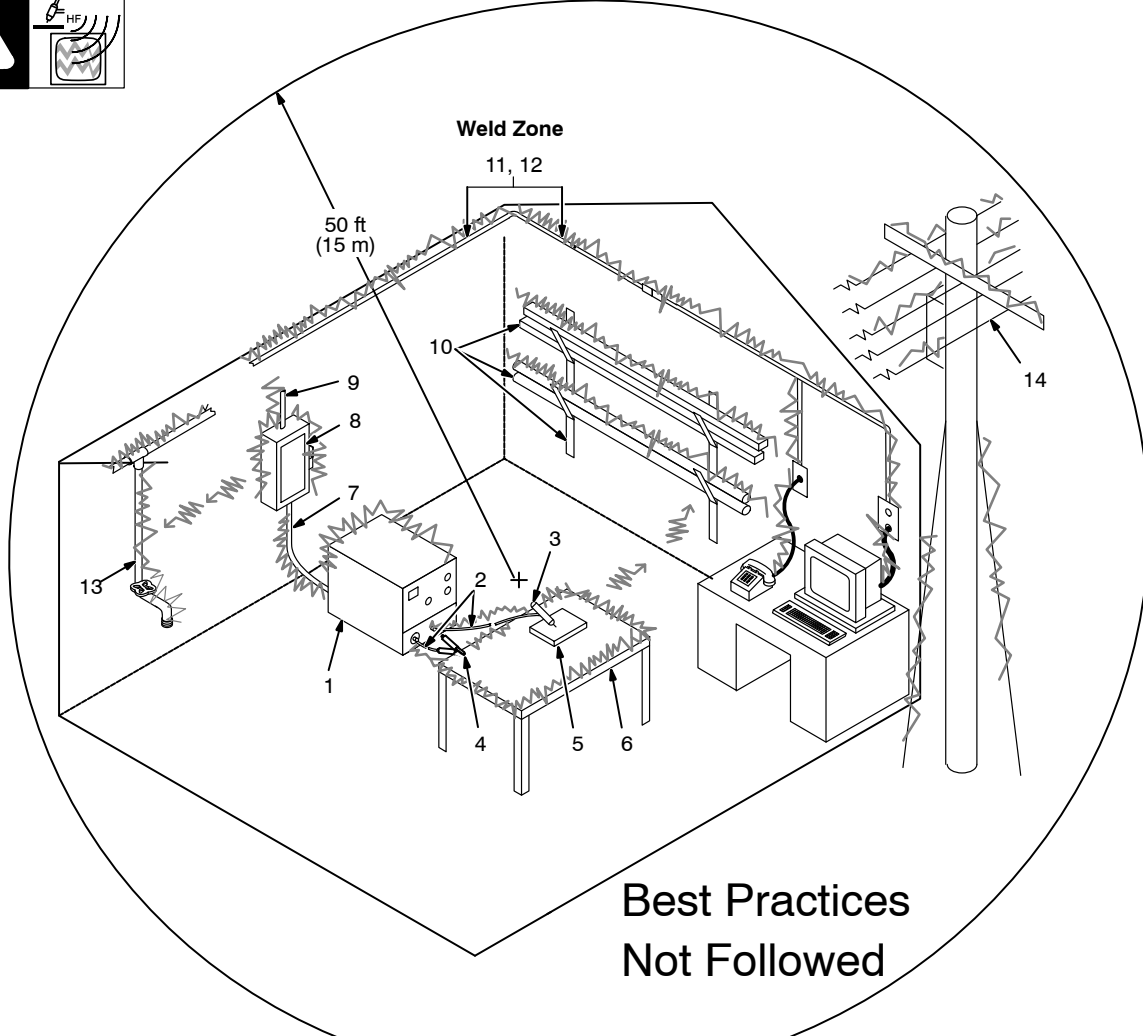

Best Practices
Not Followed

Sources of Direct High-Frequency Radiation

- 1 High-Frequency Source (welding power source with built-in HF or separate HF unit)
- 2 Weld Cables
- 3 Torch
- 4 Work Clamp
- 5 Workpiece
- 6 Work Table

Sources of Conduction of High Frequency

- 7 Input Power Cable
- 8 Line Disconnect Device
- 9 Input Supply Wiring

Sources of Reradiation of High Frequency

- 10 Ungrounded Metal Objects
- 11 Lighting
- 12 Wiring
- 13 Water Pipes and Fixtures
- 14 External Phone and Power Lines

S-0694

10-3. Recommended Installation To Reduce HF Interference

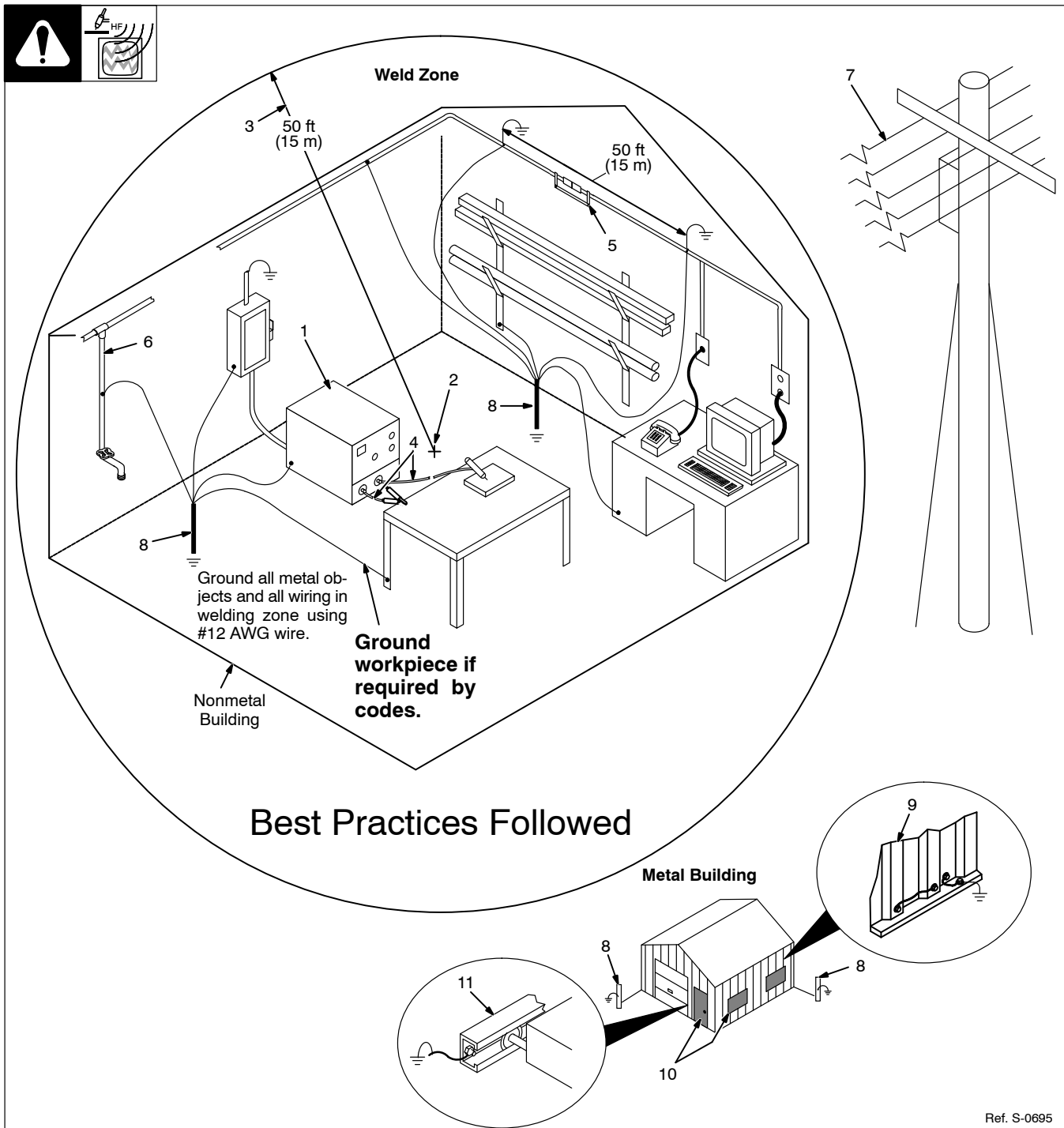

Best Practices Followed

- 1 High-Frequency Source (welding power source with built-in HF or separate HF unit)
Ground metal machine case (clean paint from around hole in case, and use case screw), work output terminal, line disconnect device, input supply, and worktable.
- 2 Center Point of Welding Zone
Midpoint between high-frequency source and welding torch.
- 3 Welding Zone
A circle 50 ft (15 m) from center point in all directions.
- 4 Weld Output Cables
Keep cables short and close together.

- 5 Conduit Joint Bonding and Grounding
Electrically join (bond) all conduit sections using copper straps or braided wire. Ground conduit every 50 ft (15 m).
- 6 Water Pipes and Fixtures
Ground water pipes every 50 ft (15 m).
- 7 External Power or Telephone Lines
Locate high-frequency source at least 50 ft (15 m) away from power and phone lines.
- 8 Grounding Rod
Consult the National Electrical Code for specifications.

- Metal Building Requirements**
- 9 Metal Building Panel Bonding Methods
Bolt or weld building panels together, install copper straps or braided wire across seams, and ground frame.
 - 10 Windows and Doorways
Cover all windows and doorways with grounded copper screen of not more than 1/4 in (6.4 mm) mesh.
 - 11 Overhead Door Track
Ground the track.

Ref. S-0695

SECTION 11 – SELECTING AND PREPARING A TUNGSTEN FOR DC OR AC WELDING WITH INVERTER MACHINES

gtaw_Inverter_2018-01



Whenever possible and practical, use DC weld output instead of AC weld output.

11-1. Selecting Tungsten Electrode (Wear Clean Gloves To Prevent Contamination Of Tungsten)

A. Select Tungsten Electrode.

☞ Not all tungsten electrode manufacturers use the same colors to identify tungsten type. Contact the tungsten electrode manufacturer or reference the product packaging to identify the tungsten you are using.

Electrode Diameter	Amperage Range - Gas Type ♦ - Polarity	
	(DCEN) – Argon Direct Current Electrode Negative (For Use With Mild Or Stainless Steel)	AC – Argon Unbalanced Wave (For Use With Aluminum)
2% Ceriated, 1.5% Lanthanum, Or 2% Thorium Alloy Tungstens		
.010 in. (.25 mm)	Up to 15	Up to 15
.020 in. (.50 mm)	5-20	5-20
.040 in. (1 mm)	15-80	15-80
1/16 in. (1.6 mm)	70-150	70-150
3/32 in. (2.4 mm)	150-250	140-235
1/8 in. (3.2 mm)	250-400	225-325
5/32 in. (4.0 mm)	400-500	300-400
3/16 in (4.8 mm)	500-750	400-500
1/4 in. (6.4 mm)	750-1000	500-630

♦ Typical argon shielding gas flow rates are 10 to 25 CFH (cubic feet per hour).

Figures listed are a guide and are a composite of recommendations from American Welding Society (AWS).

11-2. Preparing Tungsten Electrode For DC Electrode Negative (DCEN) Welding Or AC Welding With Inverter Machines



Grinding the tungsten electrode produces dust and flying sparks which can cause injury and start fires. Use local exhaust (forced ventilation) at the grinder or wear an approved respirator. Read MSDS for safety information. Consider using tungsten containing ceria, lanthana, or yttria instead of thoria. Grinding dust from thoriated electrodes contains low-level radioactive material. Properly dispose of grinder dust in an environmentally safe way. Wear proper face, hand, and body protection. Keep flammables away.

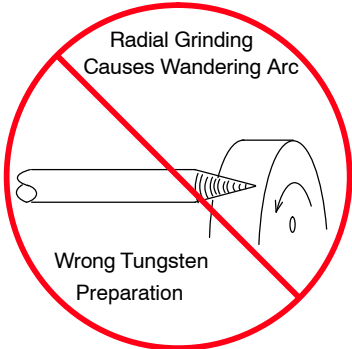

Radial Grinding Causes Wandering Arc

Wrong Tungsten Preparation

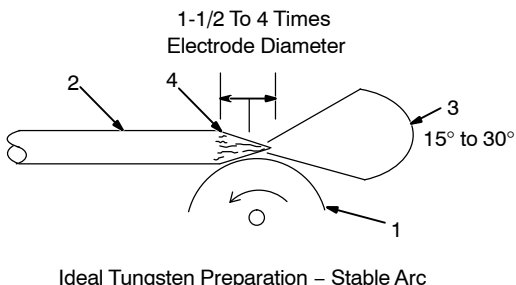

1-1/2 To 4 Times Electrode Diameter

15° to 30°

Ideal Tungsten Preparation – Stable Arc

- 1 Grinding Wheel
Grind end of tungsten on fine grit, hard abrasive wheel before welding. Do not use wheel for other jobs or tungsten can become contaminated causing lower weld quality.
- 2 Tungsten Electrode
A 2% ceriated tungsten is recommended.
- 3 Ideal Grind Angle Range: 15° to 30°
☞ 30 degrees is the recommended electrode grind angle.
- 4 Straight Ground
Grind lengthwise, **not radial**.

SECTION 12 – STICK WELDING (SMAW) GUIDELINES

12-1. Electrode And Amperage Selection Chart

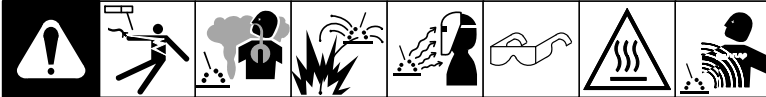

ELECTRODE	DIAMETER	AMPERAGE RANGE										
		50	100	150	200	250	300	350	400	450		
6010 & 6011	3/32	■										
	1/8		■									
	5/32			■								
	3/16				■							
	7/32					■						
6013	1/4					■						
	1/16	■										
	5/64		■									
	3/32			■								
	1/8				■							
	5/32					■						
	3/16						■					
7014	7/32						■					
	1/4							■				
	3/32								■			
	1/8									■		
	5/32										■	
7018	3/16										■	
	7/32											■
	1/4											■
	5/32											■
	3/16											■
7024	7/32											■
	1/4											■
	3/32											■
	1/8											■
	5/32											■
Ni-Ci	3/16											■
	5/32											■
	3/32											■
308L	1/8											■
	5/32											■

ELECTRODE	DC*	AC	POSITION	PENETRATION	USAGE
6010	EP		ALL	DEEP	MIN. PREP, ROUGH HIGH SPATTER
6011	EP	✓	ALL	DEEP	
6013	EP,EN	✓	ALL	LOW	GENERAL
7014	EP,EN	✓	ALL	MED	SMOOTH, EASY, FAST
7018	EP	✓	ALL	MED	LOW HYDROGEN, STRONG
7024	EP,EN	✓	FLAT HORIZ*	LOW	SMOOTH, EASY, FASTER
NI-CL	EP	✓	ALL	LOW	CAST IRON
308L	EP	✓	ALL	LOW	STAINLESS

*EP = ELECTRODE POSITIVE (REVERSE POLARITY)
EN = ELECTRODE NEGATIVE (STRAIGHT POLARITY)

Ref. S-087985-A

Notes

DECIMAL EQUIVALENTS

	$\frac{1}{64}$.015625
	$\frac{1}{32}$.03125
	$\frac{3}{64}$.046875
$\frac{1}{16}$	$\frac{5}{64}$.0625
	$\frac{7}{64}$.078125
	$\frac{9}{32}$.09375
$\frac{1}{8}$	$\frac{11}{64}$.109375
	$\frac{13}{64}$.125
	$\frac{15}{32}$.140625
	$\frac{17}{64}$.15625
$\frac{3}{16}$	$\frac{19}{64}$.171875
	$\frac{21}{64}$.1875
	$\frac{23}{32}$.203125
	$\frac{25}{64}$.21875
$\frac{1}{4}$	$\frac{27}{64}$.234375
	$\frac{29}{64}$.25
	$\frac{31}{32}$.265625
	$\frac{33}{64}$.28125
$\frac{5}{16}$	$\frac{35}{64}$.296875
	$\frac{37}{64}$.3125
	$\frac{39}{32}$.328125
	$\frac{41}{64}$.34375
$\frac{3}{8}$	$\frac{43}{64}$.359375
	$\frac{45}{64}$.375
	$\frac{47}{32}$.390625
	$\frac{49}{64}$.40625
$\frac{7}{16}$	$\frac{51}{64}$.421875
	$\frac{53}{64}$.4375
	$\frac{55}{32}$.453125
	$\frac{57}{64}$.46875
$\frac{1}{2}$	$\frac{59}{64}$.484375
	$\frac{61}{64}$.5
	$\frac{63}{32}$.515625
	$\frac{65}{64}$.53125
$\frac{9}{16}$	$\frac{67}{64}$.546875
	$\frac{69}{64}$.5625
	$\frac{71}{32}$.578125
	$\frac{73}{64}$.59375
$\frac{5}{8}$	$\frac{75}{64}$.609375
	$\frac{77}{64}$.625
	$\frac{79}{32}$.640625
	$\frac{81}{64}$.65625
$\frac{11}{16}$	$\frac{83}{64}$.671875
	$\frac{85}{64}$.6875
	$\frac{87}{32}$.703125
	$\frac{89}{64}$.71875
$\frac{3}{4}$	$\frac{91}{64}$.734375
	$\frac{93}{64}$.75
	$\frac{95}{32}$.765625
	$\frac{97}{64}$.78125
$\frac{13}{16}$	$\frac{99}{64}$.796875
	$\frac{101}{64}$.8125
	$\frac{103}{32}$.828125
	$\frac{105}{64}$.84375
$\frac{7}{8}$	$\frac{107}{64}$.859375
	$\frac{109}{64}$.875
	$\frac{111}{32}$.890625
	$\frac{113}{64}$.90625
$\frac{15}{16}$	$\frac{115}{64}$.921875
	$\frac{117}{64}$.9375
	$\frac{119}{32}$.953125
	$\frac{121}{64}$.96875
$\frac{1}{1}$	$\frac{123}{64}$.984375
	$\frac{125}{64}$	1.

TRUE BLUE[®]

WARRANTY

Effective January 1, 2019

(Equipment with a serial number preface of MK or newer)

This limited warranty supersedes all previous Miller warranties and is exclusive with no other guarantees or warranties expressed or implied.

LIMITED WARRANTY – Subject to the terms and conditions below, Miller Electric Mfg. LLC, Appleton, Wisconsin, warrants to authorized distributors that new Miller equipment sold after the effective date of this limited warranty is free of defects in material and workmanship at the time it is shipped by Miller. THIS WARRANTY IS EXPRESSLY IN LIEU OF ALL OTHER WARRANTIES, EXPRESS OR IMPLIED, INCLUDING THE WARRANTIES OF MERCHANTABILITY AND FITNESS.

Within the warranty periods listed below, Miller will repair or replace any warranted parts or components that fail due to such defects in material or workmanship. Miller must be notified in writing within thirty (30) days of such defect or failure, at which time Miller will provide instructions on the warranty claim procedures to be followed. Notifications submitted as online warranty claims must provide detailed descriptions of the fault and troubleshooting steps taken to diagnose failed parts. Warranty claims that lack the required information as defined in the Miller Service Operation Guide (SOG) may be denied by Miller.

Miller shall honor warranty claims on warranted equipment listed below in the event of a defect within the warranty coverage time periods listed below. Warranty time periods start on the delivery date of the equipment to the end-user purchaser, or 12 months after the equipment is shipped to a North American distributor, or 18 months after the equipment is shipped to an international distributor, whichever occurs first.

1. 5 Years Parts — 3 Years Labor
 - * Original Main Power Rectifiers Only to Include SCRs, Diodes, and Discrete Rectifier Modules
2. 3 Years — Parts and Labor Unless Specified
 - * Auto-Darkening Helmet Lenses (No Labor) (See Classic Series Exception Below)
 - * Engine Driven Welder/Generators
(NOTE: Engines are Warranted Separately by the Engine Manufacturer.)
 - * Insight Welding Intelligence Products
 - * Inverter Power Sources
 - * Plasma Arc Cutting Power Sources
 - * Process Controllers
 - * Semi-Automatic and Automatic Wire Feeders
 - * Transformer/Rectifier Power Sources
3. 2 Years — Parts and Labor
 - * Auto-Darkening Helmet Lenses – Classic Series Only (No Labor)
 - * Auto-Darkening Weld Masks (No Labor)
 - * Fume Extractors – Capture 5, Filtair 400 and Industrial Collector Series
4. 1 Year — Parts and Labor Unless Specified
 - * AugmentedArc and LiveArc Welding Systems
 - * Automatic Motion Devices
 - * Bernard BTB Air-Cooled MIG Guns (No Labor)
 - * CoolBelt and CoolBand Blower Unit (No Labor)
 - * Desiccant Air Dryer System
 - * Field Options
(NOTE: Field options are covered for the remaining warranty period of the product they are installed in, or for a minimum of one year — whichever is greater.)
 - * RFCS Foot Controls (Except RFCS-RJ45)
 - * Fume Extractors – Filtair 130, MWX and SWX Series HF Units
 - * ICE/XT Plasma Cutting Torches (No Labor)
 - * Induction Heating Power Sources, Coolers
(NOTE: Digital Recorders are Warranted Separately by the Manufacturer.)
 - * Load Banks
 - * Motor-Driven Guns (except Spoolmate Spoolguns)
 - * PAPR Blower Unit (No Labor)
 - * Positioners and Controllers
 - * Racks (For Housing Multiple Power Sources)
 - * Running Gear/Trailers
 - * Spot Welders

- * Subarc Wire Drive Assemblies
 - * TIG Torches (No Labor)
 - * Tregaskiss Guns (No Labor)
 - * Water Cooling Systems
 - * Wireless Remote Foot/Hand Controls and Receivers
 - * Work Stations/Weld Tables (No Labor)
5. 6 Months — Parts
 - * Batteries
 6. 90 Days — Parts
 - * Accessories (Kits)
 - * Canvas Covers
 - * Induction Heating Coils and Blankets, Cables, and Non-Electronic Controls
 - * M-Guns
 - * MIG Guns, Subarc (SAW) Torches, and External Cladding Heads
 - * Remote Controls and RFCS-RJ45
 - * Replacement Parts (No labor)
 - * Spoolmate Spoolguns

Miller's True Blue[®] Limited Warranty shall not apply to:

1. **Consumable components; such as contact tips, cutting nozzles, contactors, brushes, relays, work station table tops and welding curtains, or parts that fail due to normal wear. (Exception: brushes and relays are covered on all engine-driven products.)**
2. Items furnished by Miller, but manufactured by others, such as engines or trade accessories. These items are covered by the manufacturer's warranty, if any.
3. Equipment that has been modified by any party other than Miller, or equipment that has been improperly installed, improperly operated or misused based upon industry standards, or equipment which has not had reasonable and necessary maintenance, or equipment which has been used for operation outside of the specifications for the equipment.
4. Defects caused by accident, unauthorized repair, or improper testing.

MILLER PRODUCTS ARE INTENDED FOR COMMERCIAL AND INDUSTRIAL USERS TRAINED AND EXPERIENCED IN THE USE AND MAINTENANCE OF WELDING EQUIPMENT.

The exclusive remedies for warranty claims are, at Miller's option, either: (1) repair; or (2) replacement; or, if approved in writing by Miller, (3) the pre-approved cost of repair or replacement at an authorized Miller service station; or (4) payment of or credit for the purchase price (less reasonable depreciation based upon use). Products may not be returned without Miller's written approval. Return shipment shall be at customer's risk and expense.

The above remedies are F.O.B. Appleton, WI, or Miller's authorized service facility. Transportation and freight are the customer's responsibility. TO THE EXTENT PERMITTED BY LAW, THE REMEDIES HEREIN ARE THE SOLE AND EXCLUSIVE REMEDIES REGARDLESS OF THE LEGAL THEORY. IN NO EVENT SHALL MILLER BE LIABLE FOR DIRECT, INDIRECT, SPECIAL, INCIDENTAL OR CONSEQUENTIAL DAMAGES (INCLUDING LOSS OF PROFIT) REGARDLESS OF THE LEGAL THEORY. ANY WARRANTY NOT PROVIDED HEREIN AND ANY IMPLIED WARRANTY, GUARANTY, OR REPRESENTATION, INCLUDING ANY IMPLIED WARRANTY OF MERCHANTABILITY OR FITNESS FOR PARTICULAR PURPOSE, ARE EXCLUDED AND DISCLAIMED BY MILLER.

Some US states do not allow limiting the duration of an implied warranty or the exclusion of certain damages, so the above limitations may not apply to you. This warranty provides specific legal rights, and other rights may be available depending on your state. In Canada, some provinces provide additional warranties or remedies, and to the extent the law prohibits their waiver, the limitations set out above may not apply. This Limited Warranty provides specific legal rights, and other rights may be available, but may vary by province.

Warranty Questions?

Call
1-800-4-A-MILLER
for your local
Miller distributor.

Your distributor also gives you ...

Service

You always get the fast, reliable response you need. Most replacement parts can be in your hands in 24 hours.

Support

Need fast answers to the tough welding questions? Contact your distributor. The expertise of the distributor and Miller is there to help you, every step of the way.





Owner's Record

Please complete and retain with your personal records.

Model Name

Serial/Style Number

Purchase Date

(Date which equipment was delivered to original customer.)

Distributor

Address

City

State

Zip



For Service

Contact a DISTRIBUTOR or SERVICE AGENCY near you.

Always provide Model Name and Serial/Style Number.

Contact your Distributor for:

Welding Supplies and Consumables

Options and Accessories

Personal Safety Equipment

Service and Repair

Replacement Parts

Training (Schools, Videos, Books)

Technical Manuals (Servicing Information and Parts)

Circuit Diagrams

Welding Process Handbooks

To locate a Distributor or Service Agency visit www.millerwelds.com or call 1-800-4-A-Miller

Contact the Delivering Carrier to:

File a claim for loss or damage during shipment.

For assistance in filing or settling claims, contact your distributor and/or equipment manufacturer's Transportation Department.

Miller Electric Mfg. LLC

An Illinois Tool Works Company
1635 West Spencer Street
Appleton, WI 54914 USA

International Headquarters—USA

USA Phone: 920-735-4505 Auto-Attended
USA & Canada FAX: 920-735-4134
International FAX: 920-735-4125

For International Locations Visit
www.MillerWelds.com

